IN.CONTRO

MARBLE
SOUL

SIX
SIZES

3
COLORS

2
GRAPHICS

PORCELAIN STONEWARE

MADE IN ITALY



Design your life

La bellezza senza tempo del
travertino, il linguaggio dell'interior
design contemporaneo //
Due anime genuine ed eleganti, due
look perfettamente abbinabili //
Tre varianti cromatiche dal feeling
naturale, per una collezione
all'altezza di qualsiasi progetto //

The timeless beauty of the
travertine look, the language
of contemporary interior
design //
Two genuine and elegant
souls, two perfectly paired
looks //
Three chromatic variations
featuring a natural vibe, for
a collection worthy of any
project //

La beauté intemporelle de
l'effet travertin, le langage
du design d'intérieur
contemporain //
Deux esprits authentiques
et élégants, deux looks
parfaitement compatibles //
Trois variantes chromatiques
effet naturel pour une
collection adaptée à tous les
projets //

Die zeitlose Schönheit der
Travertino-Optik, die Sprache
des kontemporären Interior
Designs //
Zwei authentische und
elegante Gemüter, zwei
perfekt kombinierbare
Ausstrahlungen //
Drei Farbvarianten mit einem
natürlichen Gefühl, für eine
Kollektion, die jedem Projekt
gerecht wird //

Неподвластная времени
красота эффекта
травертина находит общий
язык с современным
дизайном интерьеров //
Искренность и
элегантность характеров
этих двух материалов
позволяют получать два
идеально сочетающихся
образа //
Три цветовых варианта
вызывают ощущение
натуральности и создают
такую коллекцию, которая
может справиться с любым
проектом //

INTO THE SOUL
IN.CONTRO

I due sensi di sezionatura
“IN falda” e “CONTRO falda”
dei blocchi di travertino di cava
ispirano texture dalla
personalità inconfondibile //
Le due varianti IN e CONTRO
risultano perfettamente
abbinabili a livello cromatico //

The two directions of
travertine cuts inspire textures
with an distinct personality //
Unique in terms of dynamism
and visual impact, IN and
CONTRO may be paired
perfectly in terms of colour //

Les deux sens de découpe
du travertin inspirent des
textures à forte personnalité //
Uniques par leur dynamisme
et leur impact visuel, IN et
CONTRO ont des couleurs
parfaitement assorties //

Die zwei Travertino-
Schnitttrichtungen
inspirieren Texturen mit
einer unverkennbaren
Persönlichkeit //
IN und CONTRO lassen
sich dank der Einzigartigkeit
ihres Dynamismus und ihrer
optischen Wirkung farblich
perfekt kombinieren //

Два направления
распила травертина
создают неповторимые
фактуры с выраженной
индивидуальностью //
IN и CONTRO
обладают уникальными
динамичностью и
визуальным эффектом,
кроме того, они идеально
сочетаются по цвету //



Tre tinte naturali in linea con le tendenze dell'interior design contemporaneo // Un'ampia disponibilità di formati, fino alla lastra 120x280 cm // Mosaici e strutture a rilievo arricchiscono la posa per ambienti curati in ogni dettaglio //

Three natural shades, in line with contemporary interior design trends // A wide range of sizes, all the way up to the 120x280 cm large size tile // Embossed mosaics and textures enhance the installation for meticulous thought-out rooms //

Trois teintes naturelles, en accord avec les tendances du design d'intérieur contemporain // Une large disponibilité de formats, jusqu'à la dalle 120x280 cm // Des mosaïques et des structures en relief qui enrichissent la pose pour des espaces soignés dans les moindres détails //

Drei natürliche Farben, im Einklang mit den Trends des kontemporären Interior Designs // Eine breite Auswahl an Formaten, bis zur Platte 120x280 cm // Mosaik und Reliefstrukturen bereichern die Verlegung und gestalten bis ins kleinste Detail gepflegte Räume //

Три натуральных цвета строго следуют тенденциям современного дизайна интерьеров // Ассортимент форматов очень широк и включает в себя плиты размером 120x280 см // Мозаика и рельефная структура предлагают разнообразные виды укладки и тщательную отделку любой детали интерьеров //



RANGE
DETAILS

SIX
SIZES

THREE
FINISHINGS

120x280
48"x110"

120x120
48"x48"

100x100
40"x40"

100x100 R11
40"x40"

100x100 WAX
40"x40"

60x120
24"x48"
2cm outdoor

60x120
24"x48"

60x120 WAX
24"x48"

60x60
24"x24"

60x60 R11
24"x24"

60x60 WAX
24"x24"

30x60
12"x24"

30x60 R11
12"x24"

NATURALE

R11

WAX





6 mm	R10		120x280	48"x110"																
8,5 mm	WAX		100x100	40"x40"																
8,5 mm	R10		100x100	40"x40"																
8,5 mm	R11		100x100	40"x40"																
9,5 mm	WAX		60x60	24"x24"																
			60x120	24"x48"																
9,5 mm	R10		30x60	12"x24"																
			60x60	24"x24"																
			60x120	24"x48"																
			120x120	48"x48"																
9,5 mm	R11		30x60	12"x24"																
			60x60	24"x24"																
20 mm	R11		60x120	24"x48"																

APPLICATIONS GALLERIES

A // HOME GALLERY



32 BATHROOM
IN GREY



25 KITCHEN
IN IVORY



21 LIVING
IN CREAM



28 OPEN SPACE
CONTRO IVORY+IN IVORY



31 BEDROOM
CONTRO IVORY+IN IVORY

B // GARDEN GALLERY



12 OUTDOOR
CONTRO IVORY+IN IVORY



16 IN OUT
IN CREAM+CONTRO CREAM

C // CONTRACT GALLERY



35 SPA
CONTRO GREY



36 SHOP
CONTRO GREY+IN GREY



22 RESTAURANT
CONTRO CREAM

**B // GARDEN OUTDOOR
CONTRO IVORY**

wall outdoor
IN IVORY 120x280 . 48"x110" RETT

floor outdoor
CONTRO IVORY R11 2CM 60x120 . 24"x48" RETT
CONTRO IVORY PEZZI SPECIALI 2CM

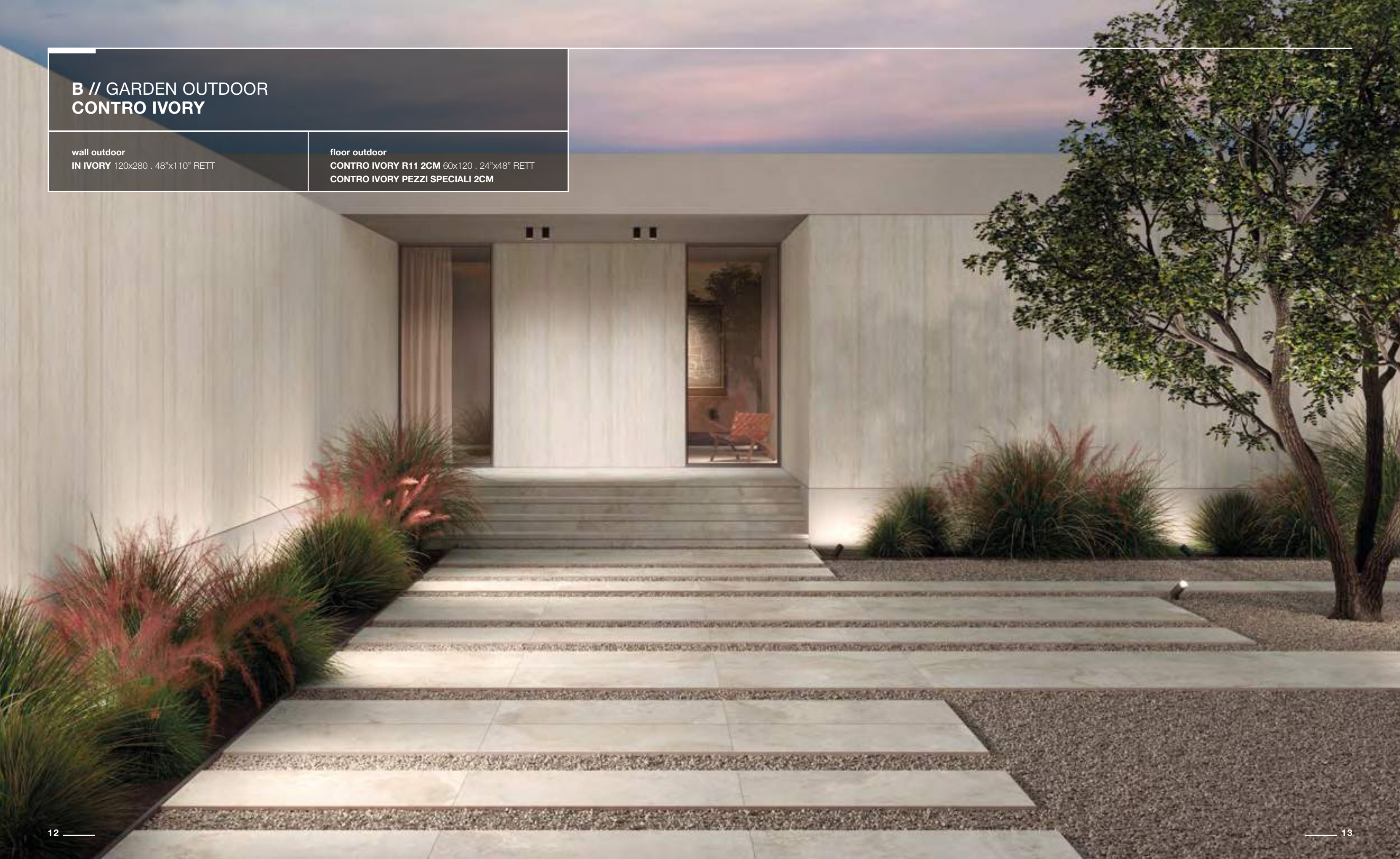



wall outdoor
IN IVORY 120x280 . 48"x110" RETT

floor outdoor
CONTRO IVORY R11 2CM 60x120 . 24"x48" RETT
CONTRO IVORY PEZZI SPECIALI 2CM

IN.CONTRO arricchisce la sua gamma con lastre da 20 mm di spessore per esterni nella versione CONTRO // Grazie alla continuità cromatica tra pavimentazione interna ed esterna, gli spazi appariranno più ampi ed eleganti //

IN.CONTRO expands its range with 20-mm thick large size tiles for outdoor use in the CONTRO version // Thanks to the chromatic continuity between indoor and outdoor flooring, spaces will appear larger and more elegant //

IN.CONTRO enrichit sa gamme avec des dalles de 20 mm d'épaisseur pour extérieurs dans la version CONTRO // Grâce à la continuité chromatique entre les sols intérieurs et extérieurs, les espaces paraîtront plus grands et plus élégants //

IN.CONTRO bereichert das Sortiment mit 20 mm dicken Platten für Außenbereiche in der Ausführung CONTRO // Dank der chromatischen Kontinuität zwischen internem und externem Bodenbelag wirken die Bereiche größer und eleganter //

IN.CONTRO пополняет свой ассортимент, предлагая плиты для наружной укладки толщиной 20 мм в варианте CONTRO // Пространства выглядят просторнее и элегантнее благодаря точному совпадению цвета внутренних и наружных полов //

**B // GARDEN IN-OUT
CONTRO CREAM + IN CREAM**

floor&wall indoor

CONTRO CREAM 100x100 . 40"x40" WAX RETT

CONTRO CREAM 100x100 . 40"x40" RETT

CONTRO CREAM MOSAICO ESAGONA 32x28 . 40"x40" RETT

floor&wall outdoor

CONTRO CREAM 100x100 . 40"x40" RETT R11

IN CREAM 60x120 . 24"x48" RETT



#ELEGANT
DECORS



wall
CONTRO CREAM MOSAICO ESAGONA 32x28 . 12⁵/₈"x11¹/₈" RETT

floor
CONTRO CREAM 60x60 . 24"x24" RETT



A // HOME LIVING IN CREAM

floor
IN CREAM 60x120 . 24"x48" WAX RETT

wall
IN CREAM 60x120 . 24"x48" RETT

IN.CONTRO interpreta il travertino in chiave moderna, per dare vita ad atmosfere dall'eleganza misurata // Le texture IN e CONTRO si caratterizzano per il disegno netto ma delicato, fatto di grafismi tono su tono mossi e garbati //

IN.CONTRO gives travertine a modern twist, to create atmospheres of measured elegance // The IN and CONTRO textures are characterized by a clear-cut yet delicate design, composed of rippled and graceful tone-on-tone graphic designs //

IN.CONTRO modernise le travertin pour créer des atmosphères à l'élégance sobre // Les textures IN et CONTRO se distinguent par leur design à la fois net et délicat, composé de graphismes ton sur ton animés et discrets //

IN.CONTRO interpretiert Travertino in moderner Aufmachung und ruft Atmosphären mit maßvoller Eleganz ins Leben // Die Texturen IN und CONTRO sind an ihrem deutlichen aber delikaten Design aus bewegten und angenehmen Ton-in-Ton-Grafiken erkennbar //

IN.CONTRO предлагает прочтение травертина в современном ключе, создавая атмосферу сдержанной элегантности // Текстура коллекции IN и CONTRO характеризуется четким, но нежным рисунком, состоящим из оживленных и изящных графических мотивов тон-в-тон //





**C // CONTRACT RESTAURANT
CONTRO CREAM**

floor
CONTRO CREAM 120x120 . 48"x48" RETT

wall
CONTRO CREAM 120x280 . 48"x110" RETT

floor
IN CREAM 60x120 . 24"x48" RETT



A // HOME KITCHEN IN IVORY

floor

IN IVORY 60x120 . 24"x48" RETT

wall

IN IVORY 60x120 . 24"x48" RETT

IN IVORY 60x120 . 24"x48" WAX RETT

IN IVORY PEZZI SPECIALI

Il fascino intramontabile del travertino rinasce in un gres porcellanato ultrarealistico e tecnicamente evoluto // Dalla grande lastra 120x280 cm al 30x60 cm, IN.CONTRO offre a progettisti e interior designer uno strumento di progettazione completo e versatile //

The authentic charm of travertine is reborn in an ultra-realistic and technically advanced porcelain stoneware // From the large 120x280 cm large size tile to the 30x60 cm, IN.CONTRO offers urban planners and interior designers a complete and versatile design tool //

Le charme authentique du travertin ressuscite dans un grès cérame ultraréaliste et techniquement évolué // De la grande dalle 120x280 cm au format 30x60 cm, IN.CONTRO offre aux architectes et aux designers d'intérieur un outil de conception complet et polyvalent //

Der authentische Charme von Travertino lebt in einem ultrarealistischen und technisch fortgeschrittenen Feinsteinzeug wieder auf // Von der großformatigen Platte 120x280 cm bis zum Format 30x60 cm bietet IN.CONTRO den Planern und Interior Designern ein komplettes und vielseitiges Planungsinstrument //

Этот керамогранит, объединяющий ультрареалистичность и передовые технические характеристики, воссоздает подлинное очарование травертина // В ассортимент IN.CONTRO входят как крупноформатные плиты 120x280 см, так и форматы меньших размеров, вплоть до 30x60 см, поэтому, коллекция является для архитекторов и дизайнеров интерьеров комплексным и универсальным инструментом для составления проектов //



floor
IN IVORY 60x120 . 24"x48" WAX RETT



#3D
SURFACE

**A // HOME OPEN SPACE
CONTRO IVORY + IN IVORY**

floor
CONTRO IVORY
60x120 . 24"x48" WAX RETT

wall
IN IVORY 60x120 . 24"x48" WAX RETT

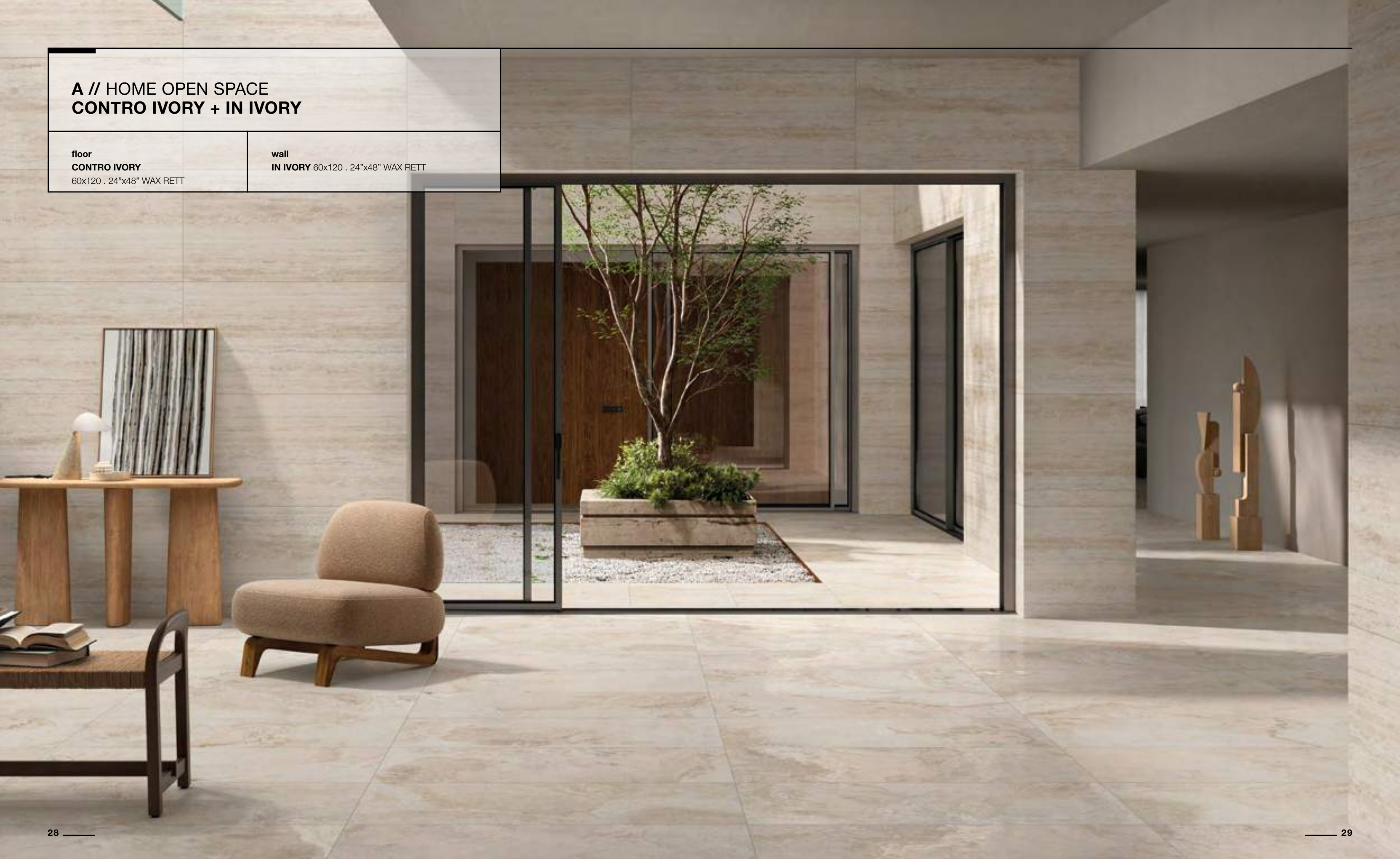

**A // HOME BEDROOM
CONTRO IVORY+IN IVORY**

floor
IN IVORY 60x120 . 24"x48" WAX RETT

wall
CONTRO IVORY 120x280 . 48"x110" RETT

floor
CONTRO IVORY 100x100 . 40"x40" WAX RETT





A // HOME BATHROOM IN GREY

floor
IN GREY 60x120 . 24"x48" RETT

wall
IN GREY LINES 60x120 . 24"x48" RETT



**C // CONTRACT SPA
CONTRO GREY**

floor
CONTRO GREY 60x60 . 24"x24" RETT R11

floor
CONTRO GREY 60x120 . 24"x48" RETT

Accanto alla finitura Naturale, opaca e materica, la superficie Lappata si anima di riflessi lucidi naturali e non omogenei //

La versione R11 per le applicazioni outdoor garantisce piena continuità estetica con le pavimentazioni da interno //

Alongside the Natural finish, matt and material, the Honed surface comes to life with non-homogeneous glossy reflections //

The R11 version for outdoor use guarantees complete aesthetic continuity with indoor floors //

La finition Naturelle, mate et texturée, s'accompagne de la surface Polie animée de reflets brillants non homogènes //

La version R11 pour les applications outdoor garantit une continuité esthétique totale avec les sols intérieurs //

Neben dem matten und materischen natürlichem Finish ‚Naturale‘ wird die geläppte Oberfläche ‚Lappata‘ von blanken, nicht homogenen Reflexen belebt //

Die Version R11 für Anwendungen in Außenbereichen garantiert eine vollkommene ästhetische Kontinuität mit den internen Bodengestaltungen //

Помимо Натуральной отделки с матовой и фактурной поверхностью предлагается также и Лаппатированная отделка, богатая неоднородными глянцевыми отблесками //

Отделка R11 для наружной укладки гарантирует полную эстетическую согласованность экстерьеров с полами в помещениях //





**C // CONTRACT SHOP
CONTRO GREY+IN GERY**

floor
CONTRO GREY 120x280 . 48"x110" RETT

wall
IN GREY 120x280 . 48"x110" RETT

wall
CONTRO GREY 100x100 . 40"x40" WAX RETT



IN IVORY



GRES PORCELLANATO SMALTATO COLORATO IN MASSA . GLAZED PORCELAIN STONeware WITH COLOURED BODY . GRÈS CÉRAME ÉMAILLÉ COLORÉ DANS LA MASSE
GLASIERTES FEINSTEINZEUG IN DER MASSE GEFÄRBT . ГЛАЗУРОВАННЫЙ КЕРАМОГРАНИТ, ОКРАШЕННЫЙ ПО ВСЕЙ ТОЛЩИНЕ



Sizes	NAT	WAX
6 MM 1/4" 120x280 . 48"x110" RETT	<input type="checkbox"/>	
9,5 MM 3/8" 60x120 . 24"x48" RETT	<input type="checkbox"/>	<input type="checkbox"/>
LINES 60x120 . 24"x48" RETT	<input type="checkbox"/>	
60x60 . 24"x24" RETT	<input type="checkbox"/>	
30x60 . 12"x24" RETT	<input type="checkbox"/>	



NAT
R10 RETT



WAX
RETT

Mosaics	NAT
9,5 MM 3/8" Mosaico Tessera 5x5 . 2"x2" 30x30 . 12"x12" RETT	<input type="checkbox"/>
Mosaico Esagona 32x28 . 12 ⁵ / ₈ "x11 ¹ / ₈ " RETT	<input type="checkbox"/>

Pezzi speciali . Special pieces . Pièces spéciales
Formteile . Специальные элементы: Pag. 46

CONTRO IVORY



GRES PORCELLANATO SMALTATO COLORATO IN MASSA . GLAZED PORCELAIN STONeware WITH COLOURED BODY . GRÈS CÉRAME ÉMAILLÉ COLORÉ DANS LA MASSE
GLASIERTES FEINSTEINZEUG IN DER MASSE GEFÄRBT . ГЛАЗУРОВАННЫЙ КЕРАМОГРАНИТ, ОКРАШЕННЫЙ ПО ВСЕЙ ТОЛЩИНЕ



Sizes	NAT	WAX	R11
6 MM 1/4" 120x280 . 48"x110" RETT	<input type="checkbox"/>		
8,5 MM 5/16" 100x100 . 40"x40" RETT	<input type="checkbox"/>	<input type="checkbox"/>	<input type="checkbox"/>
9,5 MM 3/8" 120x120 . 48"x48" RETT	<input type="checkbox"/>		
60x120 . 24"x48" RETT	<input type="checkbox"/>	<input type="checkbox"/>	
60x60 . 24"x24" RETT	<input type="checkbox"/>	<input type="checkbox"/>	<input type="checkbox"/>
30x60 . 12"x24" RETT	<input type="checkbox"/>		<input type="checkbox"/>
2 CM 13/16" 60x120 . 24"x48" RETT			<input type="checkbox"/>



NAT
R10 RETT



WAX
RETT

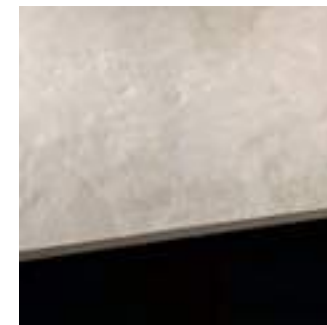

R11
R11 RETT

Mosaics	NAT
9,5 MM 3/8" Mosaico Tessera 5x5 . 2"x2" 30x30 . 12"x12" RETT	<input type="checkbox"/>
Mosaico Esagona 32x28 . 12 ⁵ / ₈ "x11 ¹ / ₈ " RETT	<input type="checkbox"/>

Pezzi speciali . Special pieces . Pièces spéciales
Formteile . Специальные элементы: Pag. 46

IN CREAM



GRES PORCELLANATO SMALTATO COLORATO IN MASSA . GLAZED PORCELAIN STONEWARE WITH COLOURED BODY . GRÈS CÉRAME ÉMAILLÉ COLORÉ DANS LA MASSE
GLASIERTES FEINSTEINZEUG IN DER MASSE GEFÄRBT . ГЛАЗУРОВАННЫЙ КЕРАМОГРАНИТ, ОКРАШЕННЫЙ ПО ВСЕЙ ТООЛЩИНЕ



Sizes	NAT	WAX
6 MM 1/4" 120x280 . 48"x110" RETT	<input type="checkbox"/>	
9,5 MM 3/8" 60x120 . 24"x48" RETT	<input type="checkbox"/>	<input type="checkbox"/>
LINES 60x120 . 24"x48" RETT	<input type="checkbox"/>	
60x60 . 24"x24" RETT	<input type="checkbox"/>	
30x60 . 12"x24" RETT	<input type="checkbox"/>	



NAT
R10 RETT



WAX
RETT

Mosaics	NAT
9,5 MM 3/8" Mosaico Tessera 5x5 . 2"x2" 30x30 . 12"x12" RETT	<input type="checkbox"/>
Mosaico Esagona 32x28 . 12 ⁵ / ₈ "x11 ¹ / ₈ " RETT	<input type="checkbox"/>

Pezzi speciali . Special pieces . Pièces spéciales
Formteile . Специальные элементы: Pag. 46

CONTRO CREAM



GRES PORCELLANATO SMALTATO COLORATO IN MASSA . GLAZED PORCELAIN STONEWARE WITH COLOURED BODY . GRÈS CÉRAME ÉMAILLÉ COLORÉ DANS LA MASSE
GLASIERTES FEINSTEINZEUG IN DER MASSE GEFÄRBT . ГЛАЗУРОВАННЫЙ КЕРАМОГРАНИТ, ОКРАШЕННЫЙ ПО ВСЕЙ ТООЛЩИНЕ



Sizes	NAT	WAX	R11
6 MM 1/4" 120x280 . 48"x110" RETT	<input type="checkbox"/>		
8,5 MM 5/16" 100x100 . 40"x40" RETT	<input type="checkbox"/>	<input type="checkbox"/>	<input type="checkbox"/>
9,5 MM 3/8" 120x120 . 48"x48" RETT	<input type="checkbox"/>		
60x120 . 24"x48" RETT	<input type="checkbox"/>	<input type="checkbox"/>	
60x60 . 24"x24" RETT	<input type="checkbox"/>	<input type="checkbox"/>	<input type="checkbox"/>
30x60 . 12"x24" RETT	<input type="checkbox"/>		<input type="checkbox"/>
2 CM 13/16" 60x120 . 24"x48" RETT			<input type="checkbox"/>

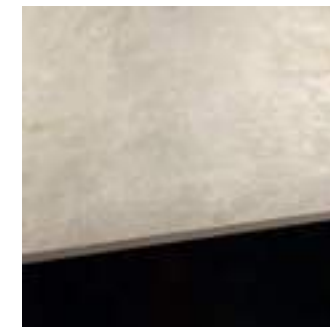

NAT
R10 RETT

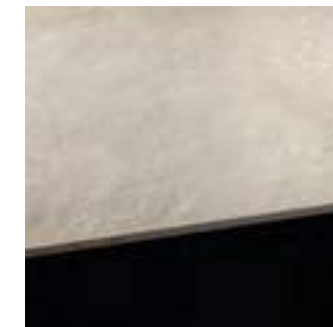

WAX
RETT



R11
R11 RETT

Mosaics	NAT
9,5 MM 3/8" Mosaico Tessera 5x5 . 2"x2" 30x30 . 12"x12" RETT	<input type="checkbox"/>
Mosaico Esagona 32x28 . 12 ⁵ / ₈ "x11 ¹ / ₈ " RETT	<input type="checkbox"/>

Pezzi speciali . Special pieces . Pièces spéciales
Formteile . Специальные элементы: Pag. 46

IN GREY



GRES PORCELLANATO SMALTATO COLORATO IN MASSA . GLAZED PORCELAIN STONEWARE WITH COLOURED BODY . GRÈS CÉRAME ÉMAILLÉ COLORÉ DANS LA MASSE
GLASIERTES FEINSTEINZEUG IN DER MASSE GEFÄRBT . ГЛАЗУРОВАННЫЙ КЕРАМОГРАНИТ, ОКРАШЕННЫЙ ПО ВСЕЙ ТОЛЩИНЕ



Sizes	NAT	WAX
 6 MM 1/4" 120x280 . 48"x110" RETT	<input type="checkbox"/>	
 9,5 MM 3/8" 60x120 . 24"x48" RETT	<input type="checkbox"/>	<input type="checkbox"/>
 LINES 60x120 . 24"x48" RETT	<input type="checkbox"/>	
 60x60 . 24"x24" RETT	<input type="checkbox"/>	
 30x60 . 12"x24" RETT	<input type="checkbox"/>	



NAT
R10 RETT



WAX
RETT

Mosaics	NAT
 9,5 MM 3/8" Mosaico Tessera 5x5 . 2"x2" 30x30 . 12"x12" RETT	<input type="checkbox"/>
 Mosaico Esagona 32x28 . 12 ⁵ / ₈ "x11 ¹ / ₈ " RETT	<input type="checkbox"/>

Pezzi speciali . Special pieces . Pièces spéciales
Formteile . Специальные элементы: Pag. 46

CONTRO GREY



GRES PORCELLANATO SMALTATO COLORATO IN MASSA . GLAZED PORCELAIN STONEWARE WITH COLOURED BODY . GRÈS CÉRAME ÉMAILLÉ COLORÉ DANS LA MASSE
GLASIERTES FEINSTEINZEUG IN DER MASSE GEFÄRBT . ГЛАЗУРОВАННЫЙ КЕРАМОГРАНИТ, ОКРАШЕННЫЙ ПО ВСЕЙ ТОЛЩИНЕ



Sizes	NAT	WAX	R11
 6 MM 1/4" 120x280 . 48"x110" RETT	<input type="checkbox"/>		
 8,5 MM 5/16" 100x100 . 40"x40" RETT	<input type="checkbox"/>	<input type="checkbox"/>	<input type="checkbox"/>
 9,5 MM 3/8" 120x120 . 48"x48" RETT	<input type="checkbox"/>		
 60x120 . 24"x48" RETT	<input type="checkbox"/>	<input type="checkbox"/>	
 60x60 . 24"x24" RETT	<input type="checkbox"/>	<input type="checkbox"/>	<input type="checkbox"/>
 30x60 . 12"x24" RETT	<input type="checkbox"/>		<input type="checkbox"/>
 2 CM 13/16" 60x120 . 24"x48" RETT			<input type="checkbox"/>

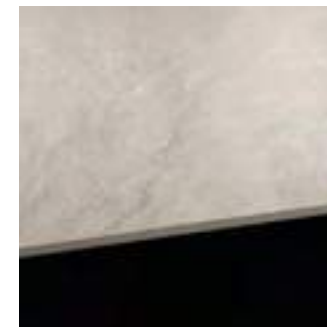

NAT
R10 RETT

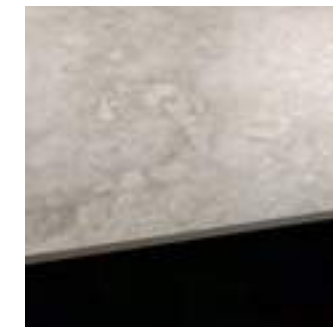

WAX
RETT



R11
R11 RETT

Mosaics	NAT
 9,5 MM 3/8" Mosaico Tessera 5x5 . 2"x2" 30x30 . 12"x12" RETT	<input type="checkbox"/>
 Mosaico Esagona 32x28 . 12 ⁵ / ₈ "x11 ¹ / ₈ " RETT	<input type="checkbox"/>

Pezzi speciali . Special pieces . Pièces spéciales
Formteile . Специальные элементы: Pag. 46

MOSAICI

MOSAICS . MOSAÏQUES . MOSAIKEN . МОЗАИКА

MOSAICO TESSERA



IN IVORY
30x30 . 12"x12"
tessera 5x5 . 2"x2" RETT



CONTRO IVORY
30x30 . 12"x12"
tessera 5x5 . 2"x2" RETT



IN CREAM
30x30 . 12"x12"
tessera 5x5 . 2"x2" RETT



CONTRO CREAM
30x30 . 12"x12"
tessera 5x5 . 2"x2" RETT



IN GREY
30x30 . 12"x12"
tessera 5x5 . 2"x2" RETT



CONTRO GREY
30x30 . 12"x12"
tessera 5x5 . 2"x2" RETT

MOSAICO ESAGONA



IN IVORY
32x28 . 12⁵/₈"x11¹/₈" RETT



CONTRO IVORY
32x28 . 12⁵/₈"x11¹/₈" RETT



IN CREAM
32x28 . 12⁵/₈"x11¹/₈" RETT



CONTRO CREAM
32x28 . 12⁵/₈"x11¹/₈" RETT



IN GREY
32x28 . 12⁵/₈"x11¹/₈" RETT



CONTRO GREY
32x28 . 12⁵/₈"x11¹/₈" RETT

LINES

DECORS . DÉCORS . DEKORE . ДЕКОРЫ



IN IVORY LINES
60x120 . 24"x48" RETT



IN CREAM LINES
60x120 . 24"x48" RETT



IN GREY LINES
60x120 . 24"x48" RETT



IN CREAM LINES 60x120 . 24"x48" RETT

wall

PEZZI SPECIALI

TRIMS . PIÈCES SPÉCIALES . FORMSTÜCKE . СПЕЦИАЛЬНЫЕ ИЗДЕЛИЯ



Battiscopa
6,5x100 . 2 9/16"x40" RETT



Battiscopa
6,5x60 . 2 9/16"x24" RETT

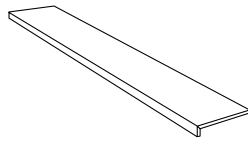

Gradone costa retta
30x120x3,3 . 12"x48"x1 5/16" RETT

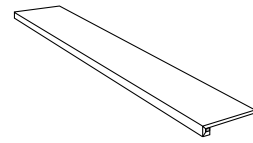

Gradone square assemblato
30x120x3,3 . 12"x48"x1 5/16" RETT



Step Molato R11
30x120 . 12"x48" RETT

Step Torato R11
30x120 . 12"x48" RETT

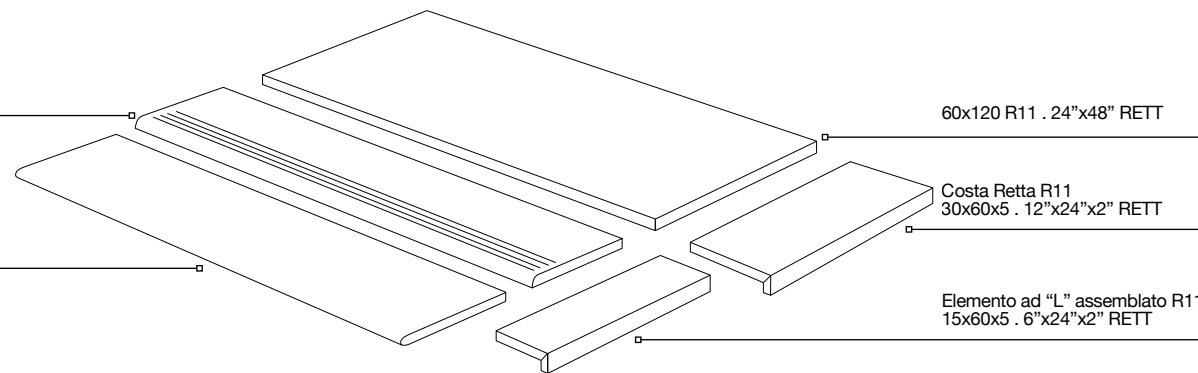

60x120 R11 . 24"x48" RETT

Costa Retta R11
30x60x5 . 12"x24"x2" RETT

Elemento ad "L" assemblato R11
15x60x5 . 6"x24"x2" RETT











PACKING

	PCS // BOX	SQM // BOX	KGS // BOX	BOXES // PALLET	SQM // PALLET	KGS // PALLET
6 MM 1/4"						
120x280 . 48"x110" RETT	1	3,36	48,80	20	67,20	1076
8,5 MM 5/16"						
100x100 . 40"x40" RETT / WAX RETT	2	2,00	38,00	24	48,00	950
100x100 . 40"x40" RETT R11	2	2,00	38,00	24	48,00	950
6,5x100 . 2 9/16"x40" BATTISCOPIA RETT	6	6,00 ml	9,00			
9,5 MM 3/8"						
120x120 . 48"x48" RETT	1	1,44	31,00	40	57,60	1300
60x120 . 24"x48" RETT / WAX RETT	2	1,44	31,00	39	56,16	1229
60x60 . 24"x24" RETT/ WAX RETT/ RETT R11	3	1,08	22,80	40	43,20	928
30x60 . 12"x24" RETT/ RETT R11	6	1,08	22,80	40	43,20	928
6,5x60 . 2 9/16"x24" BATTISCOPIA RETT	12	7,20 ml	11,00			
20 MM 13/16"						
60x120 . 24"x48" RETT R11	1	0,72	32,30	39	28,08	1280

CARATTERISTICHE TECNICHE

TECHNICAL FEATURES . CARACTÉRISTIQUES TECHNIQUES . TECHNISCHE EIGENSCHAFTEN . ТЕХНИЧЕСКИЕ ХАРАКТЕРИСТИКИ

// ufoadv.com

GRES PORCELLANATO SMALTATO COLORATO IN MASSA - ISO 13006 BIa GL GLAZED PORCELAIN STONEWARE WITH COLOURED BODY . GRÈS CÉRAME ÉMAILLÉ COLORÉ DANS LA MASSE GLASIERTES FEINSTEINZEUG IN DER MASSE GEFÄRBT . ГЛАЗУРОВАННЫЙ КЕРАМОГРАНИТ, ОКРАШЕННЫЙ ПО ВСЕЙ ТООЛЩИНЕ		IN	CONTRO	
	Aspetto superficiale Surface appearance Aspect superficiel Oberflächenbeschaffenheit Вид поверхности	≥ 95%	Conforme Compliant Conforme Konform Соответствует	Conforme Compliant Conforme Konform Соответствует
	Lunghezza e larghezza Length and width Longueur et largeur Länge und Breite Длина и ширина	Deviazione valore medio % rispetto a dimensione di fabbricazione. Deviation of the average size for each tile from the work size (%). Ecart dimensionnel moyen en % par rapport aux dimensions de fabrication. Abweichung des Durchschnittswertes in % hinsichtlich der Produktionsgröße. Отклонение средн. значения, %, от производственных размеров > 410 cm2 +/- 0,6% - ≤ 410 cm2 +/- 0,75%	± 0,5% ± 1,5 mm	± 0,5% ± 1,5 mm
	Rettilineità degli spigoli Straightness of sides Rectitude des arêtes Kantengeradheit Прямолинейность кромок	Deviazione valore medio % rispetto a dimensione di fabbricazione. Deviation of the average size for each tile from the average size to the 10 test specimens (%). Ecart de valeur moyenne unitaire % en rapport à la valeur moyenne de 10 échantillons mesurés. Abweichung des Durchschnittswertes der einzelnen Fliesen in % hinsichtlich des Durchschnitts von 10 getesteten Mustern. Отклонение средн. значения, отдельной плитки относительно средн. значения 10 измеренных образцов +/- 0,5%	± 0,5% ± 1,5 mm	± 0,5% ± 1,5 mm
	Spessore / Thickness / Epaisseur/Stärke / Толщина	+/- 5%	± 5% ± 0,5 mm	± 5% ± 0,5 mm
	Ortogonalità Rectangularity Orthogonalité Rechtwinkigkeit Ортогональность	+/- 0,5%	± 0,3% ± 1,5 mm	± 0,3% ± 1,5 mm
	Assorbimento d'acqua Water absorption Absorption d'eau Wasseraufnahme Водопоглощение	≤ 0,5% GRUPPO BIa GL	E ≤ 0,1%	E ≤ 0,1%
	Resistenza della superficie (scala MOHS) Scratch hardness (MOHS scale) Dureté de la surface (échelle MOHS) Oberflächenhärte (MOHS skala) Поверхностная прочность по (шкале Мооса)	EN 101	> 6	> 6
	Resistenza a flessione e forza di rottura Modulus of rupture and breaking strength résistance à la flexion et force de rupture Biegefestigkeit und Bruchlast Прочность на изгиб Модуль жесткости	S ≥ 1300 N R ≥ 35 N/mm2	S ≥ 1300 N R ≥ 35 N/mm2	S ≥ 1300 N R ≥ 35 N/mm2
	Resistenza alla abrasione della superficie di piastrelle smaltate Resistance to surface abrasion of glazed tiles Résistance à l'abrasion de la surface des carreaux émaillés Widerstand gegen Abrieb der Oberfläche der glasierten Fliesen Стойкость глазурованной плитки к поверхностному истиранию	Come dichiarato dal produttore See manufacturer's declaration Selon déclaration du producteur Entsprechend der Herstellerangaben Как указано изготовителем	Classe 4 Class 4 Classe 4 Gruppe 4 Класс 4	Ivory Classe 5 Class 5 Classe 5 Gruppe 4 Класс 5 Cream, Grey Classe 4 Class 4 Classe 4 Gruppe 4 Класс 4
	Coefficiente di dilatazione termica lineare Linear thermal expansion coefficient Dilatation thermique linéaire Lineare Wärmeausdehnung Кoeffициент линейного теплового расширения	Come dichiarato dal produttore See manufacturer's declaration Selon déclaration du producteur Entsprechend der Herstellerangaben Как указано изготовителем	Metodo disponibile Method available Méthode disponible Verfügbares verfahren Определяется производителем	Metodo disponibile Method available Méthode disponible Verfügbares verfahren Определяется производителем
	Resistenza allo shock termico Thermal shock resistance Résistance au choc thermique Temperaturwechselbeständigkeit Стойкость к тепловым перепадам	Nessun campione deve presentare alterazioni No sample must show visible alteration Aucun carreau ne doit présenter d'altération Muster dürfen sichtbare Veränderungen zeigen Никакой образец не должен показывать изменений	Resistente Resistant Widerstandsfähig Устойчивый	Resistente Resistant Widerstandsfähig Устойчивый
	Resistenza al gelo Frost resistance Résistance au gel Frostbeständigkeit Морозостойкость	Non devono presentare difetti visibili No sample must show visible defect Aucun carreau ne doit présenter de défaut Muster dürfen keine sichtbaren Schäden zeigen Не должны обнаруживать видимые дефекты	Ingelivo Frost proof Ingelif Frostsicher Морозостойкость	Ingelivo Frost proof Ingelif Frostsicher Морозостойкость
	Resistenza all'attacco chimico (tranne acido fluoridrico) Resistance to chemical attack (except hydrofluoric acid) Résistance à l'attaque chimique (sauf acide fluoridrique) Säure- und Laugenbeständigkeit (außer Flußsäure) Стойкость к бытовым химикатам	Nessun campione deve presentare alterazioni No sample must show visible alteration Aucun carreau ne doit présenter d'altération Muster dürfen keine sichtbaren Veränderungen zeigen Никакой образец не должен показывать изменений	Classe A-HA-LA Class A-HA-LA Classe A-HA-LA Gruppe A-HA-LA Класс A-HA-LA	Classe A-HA-LA Class A-HA-LA Classe A-HA-LA Gruppe A-HA-LA Класс A-HA-LA
	Resistenza alle macchie di piastrelle smaltate Resistance to stains of glazed tiles Résistance aux taches des carreaux émaillés Widerstand gegen Fleckenbildung der glasierten Fliesen Стойкость глазурованной плитки к образованию пятен	Nessun campione deve presentare alterazioni No sample must show visible alteration Aucun carreau ne doit présenter d'altération Muster dürfen keine sichtbaren Veränderungen zeigen Никакой образец не должен показывать изменений	Classe 5 Class 5 Classe 5 Gruppe 5 Класс 5	Classe 5 Class 5 Classe 5 Gruppe 5 Класс 5
	Resistenza alla scivolosità. Coefficiente di attrito medio Skid resistance. Average coefficient of friction Résistance au glissement. Coefficient de frottement moyen Rutschfestigkeit. Mittlerer Reibungswert Сопротивление скольжению. Средний коэффициент трения	B.C.R.A. REP. CEC. 6/81 (NO WAX) DIN EN 16165 ANNEX B ≥ R 9 (NO WAX) DIN EN 16165 ANNEX A (NO WAX) ANSI A 326.3	f ^M ≥ 0,40 R10 Classe A+B Class A+B Classe A+B Gruppe A+B Класс A+B	R10 R11 Classe A+B+C Class A+B+C Classe A+B+C Gruppe A+B+C Класс A+B+C
			f ^M ≥ 0,42	

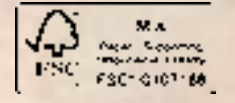

TILES FOR LIFE



Design your life

Via A. Volta 23/25 - 42013 Casalgrande (Re) Italy
Tel. +39-0522-998911/411



© Copyright 2024 Gruppo Romani S.p.A.
Gruppo Romani S.p.A. Industrie Ceramiche
www.gruppromanispa.com



IN.CONTRO

#SIZE

120x280
48"x110"

120x120
48"x48"

60x120
24"x48"

100x100
40"x40"

60x60
24"x24"

30x60
12"x24"

#INCOLORS

IVORY

CREAM

GREY

#CONTROCOLORS

IVORY

CREAM

GREY

#SURFACES

NAT

R11

WAX

Cercom is a brand of



**GRUPPO
ROMANI**

INDUSTRIE CERAMICHE SPA