

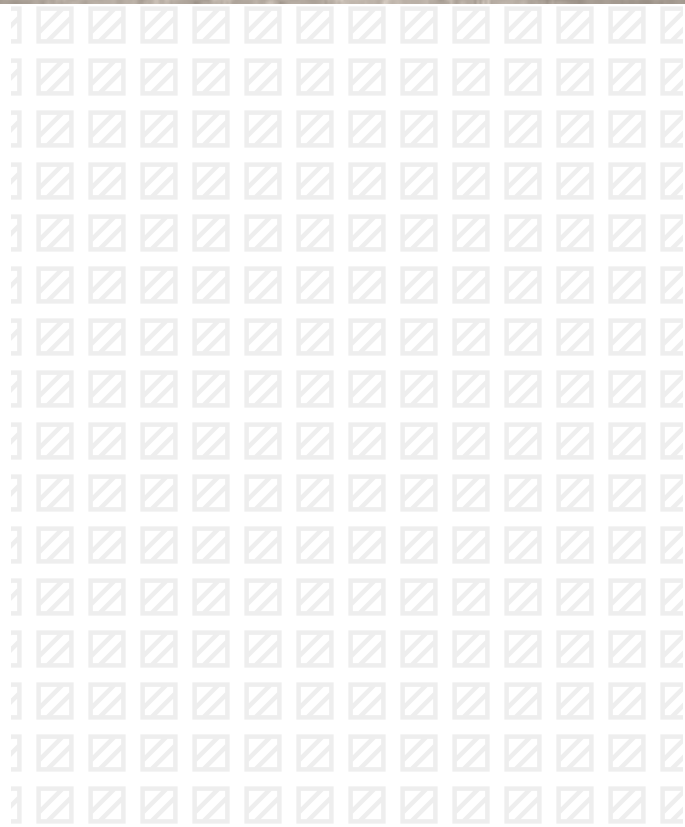

STONE & CLASSIC  
COLLECTION



UMBRIA ANTICA



**Tagina**  
ITALY'S BEST SURFACES

# UMBRIA ANTICA

Un prodotto materico ad alte prestazioni estetiche e funzionali... così nasce la bellezza del manufatto che respira.

Un grès porcellanato morbido al tatto, resistente all'usura e che si esprime in una miscela di tonalità che vanno dai colori più freddi fino ai toni più caldi, sfaccettature a contrasto creano pattern unici e di grande impatto visivo. Grazie ai grandi formati la sua destinazione finale è molteplice, sia da interno che da esterno; la soluzione ideale per ambienti contemporanei dal gusto sofisticato, un materiale ricco di storia e tradizione che sa coniugare antico e moderno.

A material product with high aesthetic and functional performances... in this way the beauty of the "breathing" product comes to life.

A porcelain tile soft to the touch, wear-resistant that is expressed in a mixture of shades starting from colder colors to warmer tones, different facets create unique patterns of great visual impact. Thanks to the large sizes, its final destination is multiple, both indoor and outdoor; the ideal solution for a contemporary spaces with a sophisticated taste, a material rich in history and tradition that combines ancient and modern.

Un produit texturé aux performances esthétiques et fonctionnelles élevées... c'est ainsi que naît la beauté du produit qui respire.

Un grès cérame doux au toucher, résistant à l'usure et s'exprimant dans un mélange de nuances allant des tons les plus froids aux plus chauds, les facettes contrastées créent des motifs uniques de grand impact visuel. Grâce à ses grandes dimensions, les possibilités d'utilisation sont innombrables, tant à l'intérieur qu'à l'extérieur: c'est la solution idéale pour les espaces contemporains au goût sophistiqué, un matériau riche en histoire et en tradition qui sait allier l'ancien et le moderne.

Ein strukturiertes Produkt mit hohen ästhetischen und funktionalen Leistungsfähigkeiten... so wird die Schönheit eines 'atmenden' Produkts ins Leben gerufen. Ein keramisches Produkt mit sanfter Oberfläche und beständig gegen Abnutzung, das sich in einem Mix von kälteren bis wärmeren Farbtönen wiederfindet und einzigartige und facettenreiche Zusammensetzungen von hohem visuellem Impact wiedergeben. Dank der Großformate sind die Anwendungsbereiche vielseitig, sowohl im Indoor als auch im Outdoor; die ideale Lösung für einen modernen Lebensstil mit besonderem Geschmack, ein Material reich an Geschichte und Tradition, das Vergangenheit und Moderne eint.

100% Made in Italy

RIVESTIMENTO . WALL  
RIVAMANCINA GRAFITE 20x120 Nat. Ret.  
BANCO . COUNTER  
Mix colori collezione Rivamancina.  
Colours mix of Rivamancina series.  
PAVIMENTO . FLOOR  
UMBRIA ANTICA BIANCO 90x90 Nat. Ret.







ANTRACITE 60x60 Nat. Ret.



ANTRACITE 90x90 20 mm Nat. Ret. R11

**FORMATI**

Sizes / Formats / Formate

**10 mm .** 90x90 - 35 1/2"x35 1/2" / 45x90 - 18"x35 1/2" / 60x120 - 24"x48" / 60x60 - 24"x24" / 30x60 - 12"x24"  
**10 mm R11 .** 45x90 - 18"x35 1/2" / 30,2x60,4 - 12"x24"  
**20 mm R11 .** 90x90 - 35 1/2"x35 1/2" / 60x120 - 24"x48" / 60x60 - 24"x24"  
**30 mm R11 .** 90x90 - 35 1/2"x35 1/2" / 60x60 - 24"x24"

**COLORI**

Colours / Couleurs / Farben



BIANCO

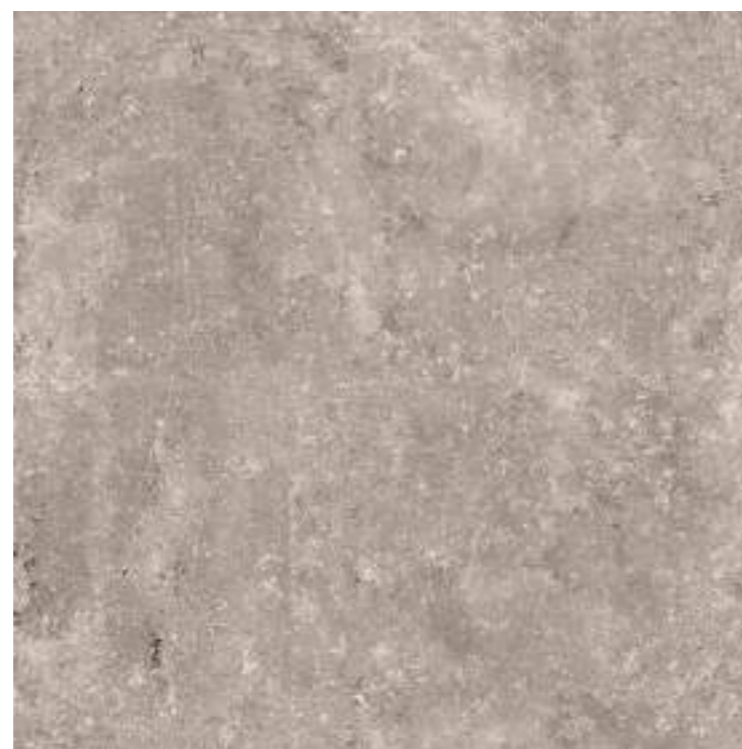

GRIGIO



ANTRACITE

**CONTINUITÀ PROGETTUALE INDOOR-OUTDOOR**

Design continuity indoors and out / Continuité conceptuelle à l'intérieur et à l'extérieur / Entwurfskontinuität im innen-und Aussenbereich



**INDOOR**



**Soluzioni contemporanee per l'interior design**  
 Contemporary solutions for interior design.  
 Solutions contemporaines pour le design intérieur.  
 Zeitgemäße Lösungen für das Interior Design.



**OUTDOOR**



**Versatilità e prestazioni per la progettazione in esterna**  
 Versatility and performance for outdoor design.  
 Polyvalence et performance pour l'aménagement extérieur.  
 Vielseitigkeit und Leistungen für Outdoor-Design.

**SISTEMI DI POSA**

Laying systems / Systemes de pose / Verlegearten

**Posa su erba**  
 Laying on grass  
 Pose sur l'herbe  
 Verlegung auf Wiese



**Posa su sabbia**  
 Laying on sand  
 Pose sur sable  
 Verlegung auf Sand



**Posa sopraelevata**  
 Raised laying  
 Pose surélevée  
 Verlegung auf Stelzlägern



**Posa su ghiaia**  
 Laying on gravel  
 Pose sur gravier  
 Verlegung auf Kies



**Posa tradizionale**  
 Standard laying  
 Pose traditionnelle  
 Herkömmliche Verlegung



**Spessore . Thickness . Epaisseur . Stärke - 10 mm**

**Gres porcellanato colorato in massa.** Full-body coloured porcelain stoneware. Grès cérame coloré dans la masse. In der Masse gefärbtes Feinsteinzeug.

**INDOOR**

TABELLA RIEPILOGATIVA  
Summary table  
Tableau récapitulatif  
Zusammenfassenden Tabelle

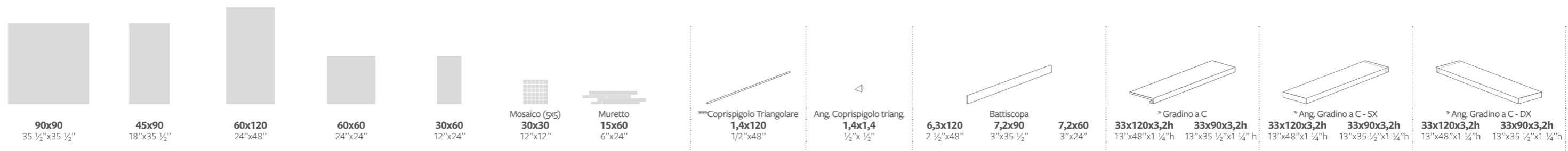

SPESSORE - THICKNESS - EPAISSEUR - STÄRKE		10 mm	10 mm	10 mm	10 mm	10 mm	10 mm	10 mm	10 mm	10 mm	10 mm	10 mm	10 mm	10 mm	10 mm	10 mm	10 mm	10 mm	10 mm		
	<b>BIANCO</b> <input type="checkbox"/> Nat. Ret.	114030	114118	114112	114095	114160	114230	114236	114247	114250	114256	114253	114250	114268	114259	114274	114265	114271	114262		
	<b>GRIGIO</b> <input type="checkbox"/> Nat. Ret.	114029	114117	114110	114094	114159	114231	114237	114248	114251	114257	114254	114251	114269	114260	114275	114266	114272	114263		
	<b>ANTRACITE</b> <input type="checkbox"/> Nat. Ret.	114031	114119	114114	114096	114161	114232	114238	114249	114252	114258	114255	114252	114270	114261	114276	114267	114273	114264		
<b>N°</b> <b>m²</b> <b>** Kg</b> <b>x</b> <b>m² x</b> <b>Kg x</b> <b>x</b> <b>m² x</b> <b>** Kg x</b> <b>h x</b> <b>Imballo (tara) - Packaging (tare)</b>																					
	<b>Pallet</b>	<b>Pallet</b>	<b>Pallet</b>	<b>Pallet</b>	<b>Pallet</b>	<b>Pallet</b>	<b>Pallet</b>	<b>Pallet</b>			<b>Pallet</b>	<b>Pallet</b>	<b>Pallet</b>	<b>Pallet</b>	<b>Pallet</b>	<b>Pallet</b>	<b>Pallet</b>	<b>Pallet</b>	<b>Pallet</b>	<b>Pallet</b>	
	94x120	94x120	94x120	80x120	80x120	80x120	80x120	80x120			80x120	80x120	80x120	80x120	80x120	80x120	80x120	80x120	80x120	80x120	

I pesi riportati in tabella sono indicativi e potrebbero essere soggetti a leggere variazioni.  
The weights stated in the chart may undergo slight changes for production reasons.  
Les poids indiqués dans le tableau peuvent subir de légères variations pour des raisons de production.  
Die in der Tabelle angegebenen Gewichte können aus Produktionsgründen geringfügigen Abweichungen unterliegen.

Non si garantisce l'abbinabilità tra fondi di spessori diversi e tra fondo e pezzo speciale.  
It is not guaranteed that background tiles with different thicknesses can be used together, nor is it guaranteed for background tiles and trims.  
Nous ne garantissons pas la possibilité de combiner des carrelages de sol de différentes épaisseurs et un carrelage de sol avec une pièce spéciale.  
Die Kombinierbarkeit von Fliesen unterschiedlicher Stärke sowie zwischen Fliese und Formteil kann nicht garantiert werden.

\* A disposizione solo su richiesta. Tempi di consegna 30 gg.  
Available upon request only. Delivery terms: 30 days.  
Disponibile seulement sur requête. Délais de livraison: 30 jours.  
Verfügbar auf Anfrage. Lieferzeit: 30 Tage.

\*\* Il peso è comprensivo dell'imballo.  
The total weight includes the packaging.  
Le poids comprend aussi l'emballage.  
Das Gesamtgewicht enthält auch die Verpackung.

\*\*\* Vendita a scatola completa.  
Full box sale.  
Vente à la boîte complète.  
Volle Kartons.

Naturale e rettificato.  
Natural and rectified.  
Naturel et rectifié.  
Natur Oberfläche und kalibriert.

**Spessore . Thickness . Epaisseur . Stärke - 10 mm R11 / 20 mm R11 / 30 mm R11**

**Gres porcellanato colorato in massa.** Full-body coloured porcelain stoneware. Grès cérame coloré dans la masse. In der Masse gefärbtes Feinsteinzeug.

**OUTDOOR**

TABELLA RIEPILOGATIVA  
Summary table  
Tableau récapitulatif  
Zusammenfassenden Tabelle

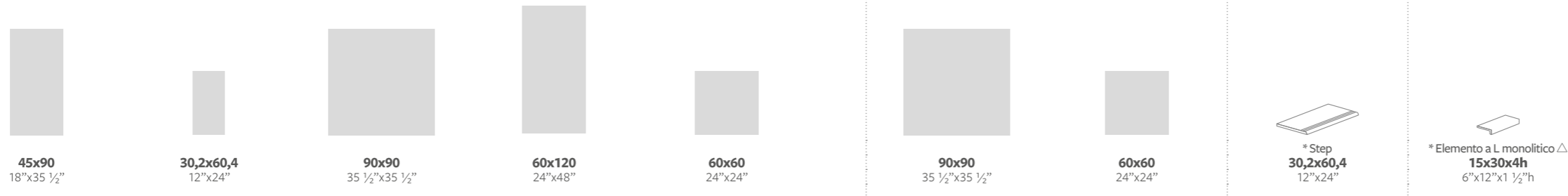

SPESSORE - THICKNESS - EPAISSEUR - STÄRKE		10 mm	10 mm	20 mm	20 mm	20 mm	30 mm	30 mm	10 mm	9,5 mm
	□ Nat. Ret.	114120		114040	114107	114100	114190	114195		
	■ Nat. Nat.		114221						114277	114280
	□ Nat. Ret.	114121		114039	114106	114099	114187	114196		
	■ Nat. Nat.		114222						114278	114281
	□ Nat. Ret.	114122		114041	114108	114101	114186	114192		
	■ Nat. Nat.		114223						114279	114282

	<b>Pallet</b>	<b>Pallet</b>	<b>Pallet</b>	<b>Pallet</b>	<b>Pallet</b>	<b>Pallet</b>	<b>Pallet</b>	<b>Pallet</b>	<b>Pallet</b>	<b>Pallet</b>
	94x120	80x120	94x94	80x120	80x120	95x95	65x120	80x120	80x120	80x120
<b>N°</b>										
<b>m²</b>										
<b>Kg</b>										
	3	6	1	1	2	1	1	6	6	6
<b>m² x</b>	1,22	1,1	0,81	0,72	0,72	0,81	0,36	1,1	1,1	1,1
<b>Kg x</b>	27	22,7	37	30	30	55	25	22,7	22,7	7,50
	30	40	30	30	32	20	44	40	40	40
<b>m² x</b>	36,6	44	24,30	21,6	23,04	16,20	15,84	44	44	44
<b>** Kg x</b>	830	928	1130	920	980	1120	1116	928	928	928
<b>h x</b>	60	76	80	76	76	78	84	76	76	76
<b>Imballo (tara) - Packaging (tare)</b>	(20)	(20)	(20)	(20)	(20)	(20)	(16)	(20)	(20)	(20)

I pesi riportati in tabella sono indicativi e potrebbero essere soggetti a leggere variazioni.  
The weights stated in the chart may undergo slight changes for production reasons.  
Les poids indiqués dans le tableau peuvent subir de légères variations pour des raisons de production.  
Die in der Tabelle angegebenen Gewichte können aus Produktionsgründen geringfügigen Abweichungen unterliegen.

Non si garantisce l'abbinabilità tra fondi di spessori diversi e tra fondo e pezzo speciale.  
It is not guaranteed that background tiles with different thicknesses can be used together, nor is it guaranteed for background tiles and trims.  
Nous ne garantissons pas la possibilité de combiner des carrelages de sol de différentes épaisseurs et un carrelage de sol avec une pièce spéciale.  
Die Kombinierbarkeit von Fliesen unterschiedlicher Stärke sowie zwischen Fliese und Formteil kann nicht garantiert werden.

○ Nuova pallettizzazione disponibile ad esaurimento dello stock esistente.  
New pallet configuration once current stock fully exhausted.  
Nouvelle palettisation disponible jusqu'à épuisement du stock existant.  
Neue Palettierung verfügbar solange der Vorrat reicht.

\* A disposizione solo su richiesta. Tempi di consegna 30 gg.  
Available upon request only. Delivery terms: 30 days.  
Disponible seulement sur requête. Délais de livraison: 30 jours.  
Verfügbar auf Anfrage. Lieferzeit: 30 Tage.

\*\* Il peso è comprensivo dell'imballo.  
The total weight includes the packaging.  
Le poids comprend aussi l'emballage.  
Das Gesamtgewicht enthält auch die Verpackung.

□ Naturale e rettificato.  
Natural and rectified.  
Naturel et rectifié.  
Natur Oberfläche und kalibriert.

■ Naturale e naturale.  
Natural and natural.  
Naturel et naturel.  
Natur natur.

△ Monolitico.  
Monolithic step.  
Monolitico.  
Monolitische Stufenplatte.











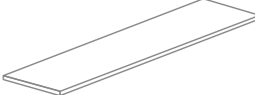





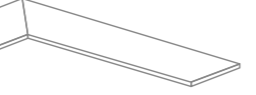



**Spessore . Thickness . Epaisseur . Stärke - 20 mm R11**









**Gres porcellanato colorato in massa.** Full-body coloured porcelain stoneware. Grès cérame coloré dans la masse. In der Masse gefärbtes Feinsteinzeug.







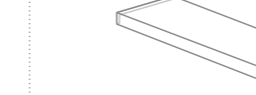

**Pezzi speciali per esterno**

Special pieces for outdoor - Pièces spéciales pour extérieur - Formteile für Aussenbereich

									
	* Gradone □ Nat. Ret.			* Ang. Gradone - SX □ Nat. Ret.			* Ang. Gradone - DX □ Nat. Ret.		
	30x120 12"x48"	30x90 12"x35 1/2"	30x60 12"x24"	30x120 12"x48"	30x90 12"x35 1/2"	30x60 12"x24"	30x120 12"x48"	30x90 12"x35 1/2"	30x60 12"x24"
<b>SPESSORE - THICKNESS - EPAISSEUR - STÄRKE</b>	<b>20 mm</b>	<b>20 mm</b>	<b>20 mm</b>	<b>20 mm</b>	<b>20 mm</b>	<b>20 mm</b>	<b>20 mm</b>	<b>20 mm</b>	<b>20 mm</b>

									
	* Gradone grip □ Nat. Ret.			* Ang. Gradone grip - SX □ Nat. Ret.			* Ang. Gradone grip - DX □ Nat. Ret.		
	30x120 12"x48"	30x90 12"x35 1/2"	30x60 12"x24"	30x120 12"x48"	30x90 12"x35 1/2"	30x60 12"x24"	30x120 12"x48"	30x90 12"x35 1/2"	30x60 12"x24"
<b>SPESSORE - THICKNESS - EPAISSEUR - STÄRKE</b>	<b>20 mm</b>	<b>20 mm</b>	<b>20 mm</b>	<b>20 mm</b>	<b>20 mm</b>	<b>20 mm</b>	<b>20 mm</b>	<b>20 mm</b>	<b>20 mm</b>

									
	* Elemento a L □ Nat. Ret.			* Elemento a L SX □ Nat. Ret.			* Elemento a L DX □ Nat. Ret.		
	33x120x4h 13"x48"x1 1/2"h	33x90x4h 13"x35 1/2"x1 1/2"h	33x60x4h 13"x24"x1 1/2"h	33x120x4h 13"x48"x1 1/2"h	33x90x4h 13"x35 1/2"x1 1/2"h	33x60x4h 13"x24"x1 1/2"h	33x120x4h 13"x48"x1 1/2"h	33x90x4h 13"x35 1/2"x1 1/2"h	33x60x4h 13"x24"x1 1/2"h
<b>SPESSORE - THICKNESS - EPAISSEUR - STÄRKE</b>	<b>20 mm</b>	<b>20 mm</b>	<b>20 mm</b>	<b>20 mm</b>	<b>20 mm</b>	<b>20 mm</b>	<b>20 mm</b>	<b>20 mm</b>	<b>20 mm</b>

							
*** piedino regolabile 25-30	*** piedino regolabile 30-37	*** piedino regolabile 37-50	*** piedino regolabile 50-75	*** piedino regolabile 75-125	*** piedino regolabile 125-225	*** prolunga piedini h 100 mm	chiave di regolazione
600101	600102	600103	600104	600105	600106	600107	600108
	20	20	20	20	20	20	1

\* A disposizione solo su richiesta. Tempi di consegna 30 gg.  
Available upon request only. Delivery terms: 30 days.  
Disponible seulement sur requête. Délais de livraison: 30 jours.  
Verfügbar auf Anfrage. Lieferzeit: 30 Tage.

\*\*\* Vendita a scatola completa.  
Full box sale.  
Vente à la boîte complète.  
Volle Kartons.

□ Naturale e rettificato.  
Natural and rectified.  
Naturel et rectifié.  
Natur Oberfläche und kalibriert.









▮ Costa retta.  
Straight edge.  
Bord droit.  
Gerade Kante.







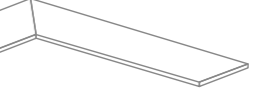

◐ Costa toro.  
Bullnose edge.  
Bord boudin.  
Abgerundete Kante.

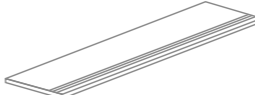





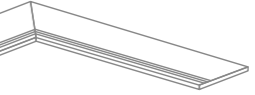

Per le condizioni generali di vendita e le caratteristiche tecniche consultare [www.tagina.it](http://www.tagina.it).  
General terms and Sales conditions and Technical features are available on our website [www.tagina.it](http://www.tagina.it).  
Les Conditions général de vente et les Caractéristiques techniques sont disponibles sur le site web [www.tagina.it](http://www.tagina.it).  
Allgemeine Verkaufsbedingungen und technische Eigenschaften sind auf unsere Website verfügbar: [www.tagina.it](http://www.tagina.it)



**Pezzi speciali per piscina**

Special pieces for swimming pool - Pièces spéciales pour piscine - Formteile für Schwimmbad

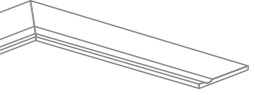
									
	* Gradone bordo piscina □ Nat. Ret.			* Ang. Gradone bordo piscina - SX □ Nat. Ret.			* Ang. Gradone bordo piscina - DX □ Nat. Ret.		
	30x120 12"x48"	30x90 12"x35 1/2"	30x60 12"x24"	30x120 12"x48"	30x90 12"x35 1/2"	30x60 12"x24"	30x120 12"x48"	30x90 12"x35 1/2"	30x60 12"x24"
<b>SPESSORE - THICKNESS - EPAISSEUR - STÄRKE</b>	<b>20 mm</b>	<b>20 mm</b>	<b>20 mm</b>	<b>20 mm</b>	<b>20 mm</b>	<b>20 mm</b>	<b>20 mm</b>	<b>20 mm</b>	<b>20 mm</b>

									
	* Gradone grip bordo piscina □ Nat. Ret.			* Ang. Gradone grip bordo piscina - SX □ Nat. Ret.			* Ang. Gradone grip bordo piscina - DX □ Nat. Ret.		
	30x120 12"x48"	30x90 12"x35 1/2"	30x60 12"x24"	30x120 12"x48"	30x90 12"x35 1/2"	30x60 12"x24"	30x120 12"x48"	30x90 12"x35 1/2"	30x60 12"x24"
<b>SPESSORE - THICKNESS - EPAISSEUR - STÄRKE</b>	<b>20 mm</b>	<b>20 mm</b>	<b>20 mm</b>	<b>20 mm</b>	<b>20 mm</b>	<b>20 mm</b>	<b>20 mm</b>	<b>20 mm</b>	<b>20 mm</b>

									
	* Gradone svasato bordo piscina □ Nat. Ret.			* Ang. Gradone svasato bordo piscina - SX □ Nat. Ret.			* Ang. Gradone svasato bordo piscina - DX □ Nat. Ret.		
	30x120 12"x48"	30x90 12"x35 1/2"	30x60 12"x24"	30x120 12"x48"	30x90 12"x35 1/2"	30x60 12"x24"	30x120 12"x48"	30x90 12"x35 1/2"	30x60 12"x24"
<b>SPESSORE - THICKNESS - EPAISSEUR - STÄRKE</b>	<b>20 mm</b>	<b>20 mm</b>	<b>20 mm</b>	<b>20 mm</b>	<b>20 mm</b>	<b>20 mm</b>	<b>20 mm</b>	<b>20 mm</b>	<b>20 mm</b>

		
* Griglia □ Nat. Ret. 20x60 8"x24"	* Griglia SX □ Nat. Ret. 20x60 8"x24"	* Griglia DX □ Nat. Ret. 20x60 8"x24"
20x60 8"x24"	20x60 8"x24"	20x60 8"x24"
<b>SPESSORE - THICKNESS - EPAISSEUR - STÄRKE</b>	<b>20 mm</b>	<b>20 mm</b>

Per maggiori informazioni su imballi e codici articolo potete consultare il nostro BOOK (anche da sito internet, nell'area "download").  
For more information on packaging and item codes, please refer to our BOOK (also available for download on our website, in the "download" area).  
Pour plus d'informations sur les emballages et les codes articles, vous pouvez consulter notre BOOK (également depuis le site, dans la zone "téléchargement").  
Weitere Informationen zu Verpackungen und Artikelcodes finden Sie in unserem BOOK (auch auf der Website, im Bereich "Download").

Tagina S.p.A. si riserva di modificare, senza alcun preavviso, il packaging dei prodotti, le grafiche, i colori e i decori riportati nelle immagini che sono pertanto da ritenersi indicative.  
Tagina S.p.A. reserves the right to change the product packaging, the patterns, colours and decorations shown in the pictures without any prior notice. These aspects, therefore should be considered for illustrative purposes only.  
Tagina S.p.A. se réserve le droit de modifier, sans préavis, l'emballage des produits, les graphismes, les couleurs et les décors représentés dans les images, fournies à titre indicatif.  
Die Tagina S.p.A. behält sich vor, die Verpackung der Produkte, die in den Abbildungen gezeigten Grafiken, Farben und Dekors sowie ohne vorherige Ankündigung zu ändern.

## PEZZI SPECIALI PER ESTERNO

Special pieces for outdoor  
Pièces spéciales pour extérieur  
Formteile für Aussenbereich

Elemento a L



Gradone grip

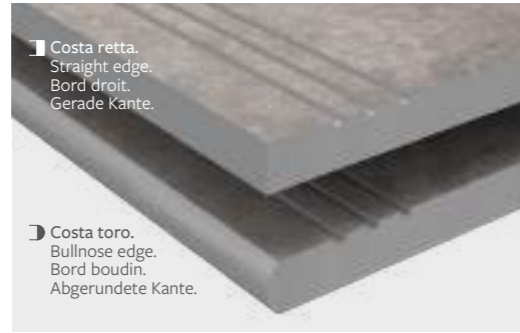

Gradone



## PEZZI SPECIALI PER PISCINA

Special pieces for swimming pool  
Pièces spéciales pour piscine  
Formteile für Schwimmbad

Gradone svasato bordo piscina



Gradone grip bordo piscina

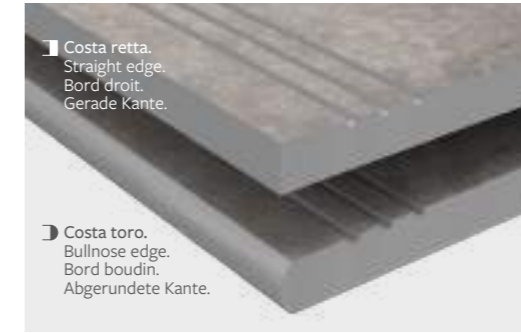

Gradone bordo piscina

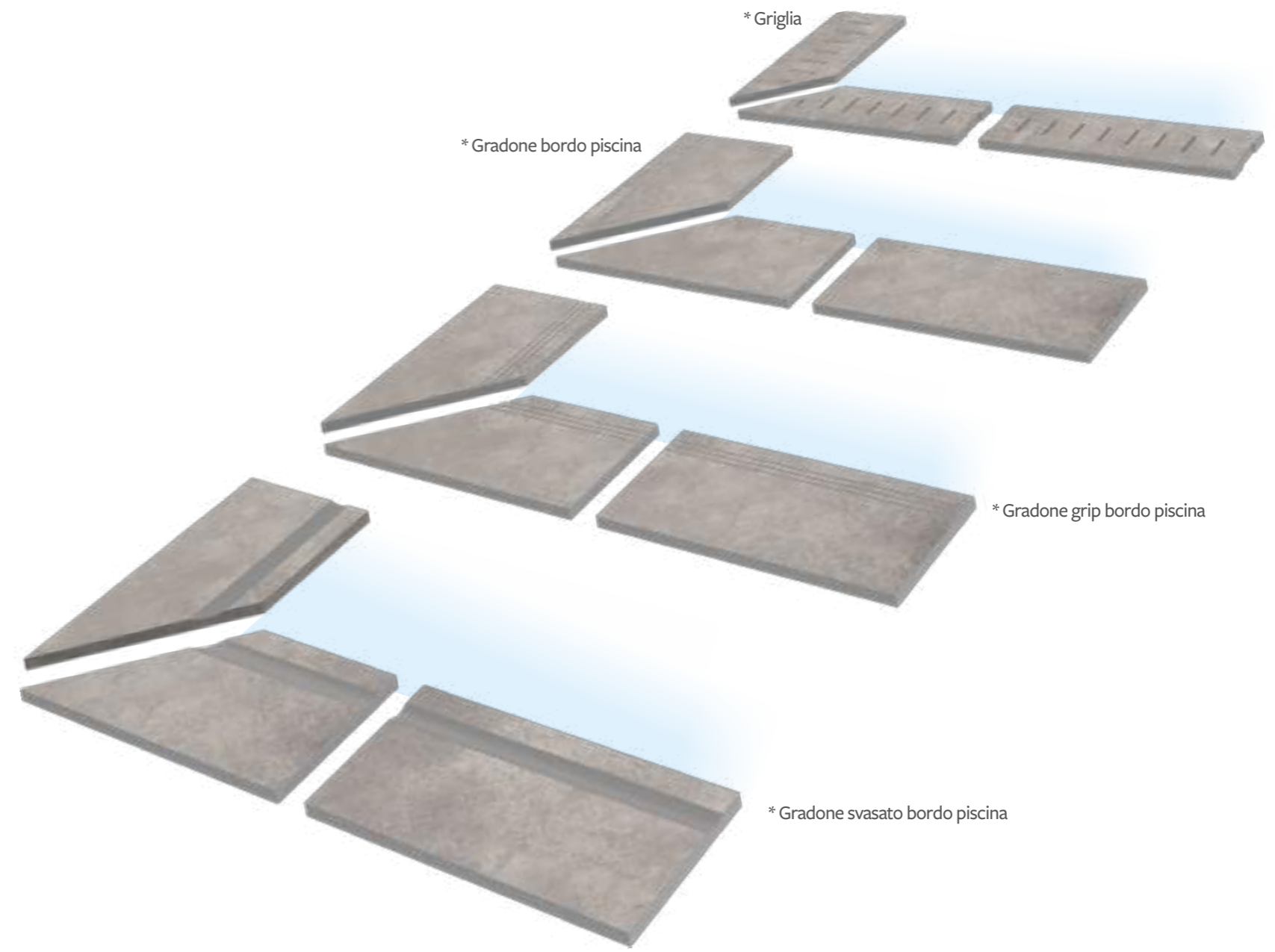
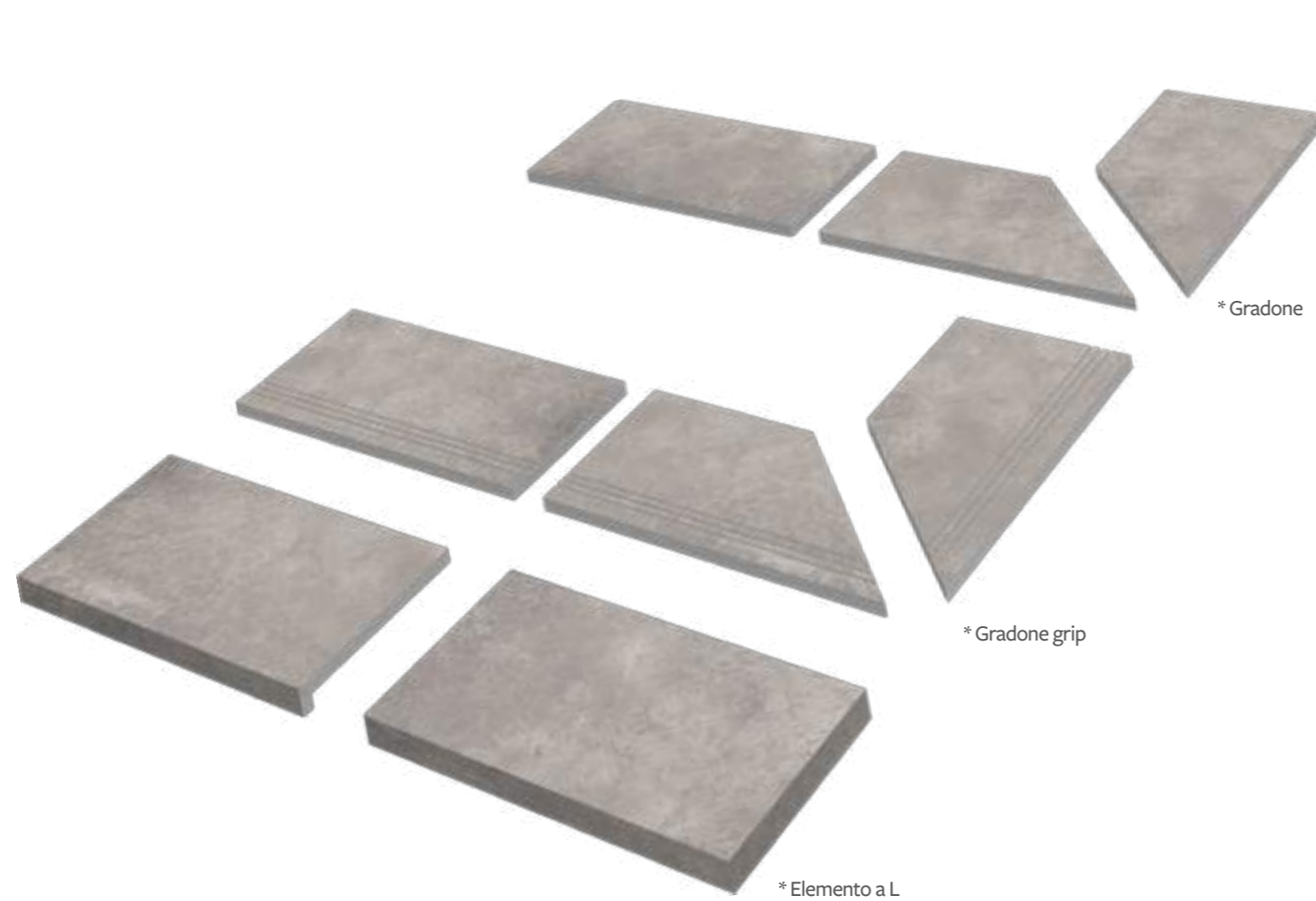

\* I tempi di consegna di tutti i pezzi speciali mostrati in queste pagine sono di 30 giorni dalla data dell'ordine.  
Delivery time for all the special pieces shown on these pages are generally 30 days from order date.  
La livraison de toutes les pièces spéciales présentées dans les pages du catalogue sont disponible 30 jours à compter de la date de commande.  
Der Liefertermin fuer die Spezialteile, die in dieser Seite aufgefuehrt sind, belaeuft sich auf 30 Tage nach Auftragseingang.



**Tagina** S.p.A.  
Via Emilia Ponente, 925  
48014 Castel Bolognese (RA) - Italy  
Tel. +39 0545 197 7303

tagina.it -  DAFIN GROUP



Follow us