



STONE & CLASSIC  
COLLECTION



NAMUR



50  
Anniversary  
| 1973 | 2023

**Tagina**  
ITALY'S BEST SURFACES

## NAMUR

**NAMUR** si ispira alla Pierre Bleu o Pietra Blu, la tipica roccia sedimentaria belga dalle caratteristiche sfumature grigio-blu. Nell'interpretazione di **Tagina**, la pietra assume molteplici tonalità di colore che spaziano dal nero al beige, fino al grigio, per un uso concepito in piena continuità cromatica e di formato tra ambienti interni ed esterni grazie alle eccezionali caratteristiche di ingelività e durezza tipiche del gres porcellanato.

**NAMUR** is inspired by Pierre Bleue or Blue Stone, the Belgian sedimentary rock with characteristic grey-blue hues. In **Tagina's** interpretation, the stone takes on multiple shades of colour ranging from black to beige, up to grey, in full chromatic and size continuity with both internal and external environments thanks to the exceptional characteristics of frost resistance and durability typical of porcelain stoneware.

**NAMUR** s'inspire de la Pierre Bleue ou Pietra Blu, la roche sédimentaire caractéristique de couleur bleu gris provenant de Belgique. Dans l'interprétation de **Tagina**, la pierre prend de multiples nuances de couleur allant du noir au beige, jusqu'au gris, pour un usage conçu en pleine continuité chromatique et dimensionnelle entre l'intérieur et l'extérieur grâce aux caractéristiques exceptionnelles de résistance au gel et de durabilité typique du grès cérame.

**NAMUR** ist inspiriert vom Pierre Bleue oder Blaustein, dem typischen belgischen Sedimentgestein mit seinen charakteristischen graublauen Farbtönen. In der Interpretation von **Tagina** nimmt der Stein mehrere Farbtöne an, die von Schwarz über Beige bis hin zu Grau reichen, für eine Verwendung, die dank der außergewöhnlichen Frostbeständigkeit und der für Feinsteinzeug typischen Dauerhaftigkeit in voller Farb- und Formatkontinuität zwischen Innen- und Außenbereichen konzipiert ist.

100% Made in Italy



## BLANCHE 2



## CENDRE 8



## FONCÉ 14

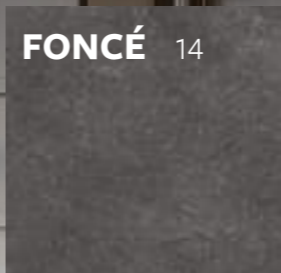

## Formati 22

Sizes.  
Formats.  
Formate.

## Colori 22

Colours.  
Couleurs.  
Farben.

## Continuità progettuale indoor-outdoor 23

Design continuity indoors and outdoors.  
Continuité conceptuelle à l'intérieur et à l'extérieur.  
Entwurfskontinuität im Innen- und Aussenbereich.

## Decori 24

Decors.  
Décors.  
Dekore.

## Tabella riepilogativa

Summary table.  
Tableau récapitulatif.  
Zusammenfassenden Tabelle.

## INDOOR 26

## OUTDOOR 28

## Pezzi speciali: massima cura in ogni dettaglio 30

Special pieces: the utmost care in every detail.  
Pièces spéciales : le soin maximal dans le moindre détail.  
Spezialteile: maximale Sorgfalt in jedem Detail.

## Suggerimenti per abbinare colori e stili Tagina 32

Tips for Matching Colours and Tagina Styles.  
Conseils pour faire correspondre les couleurs et les styles Tagina.  
Tipps für die Kombination von Tagina-Farben und -Stilen.

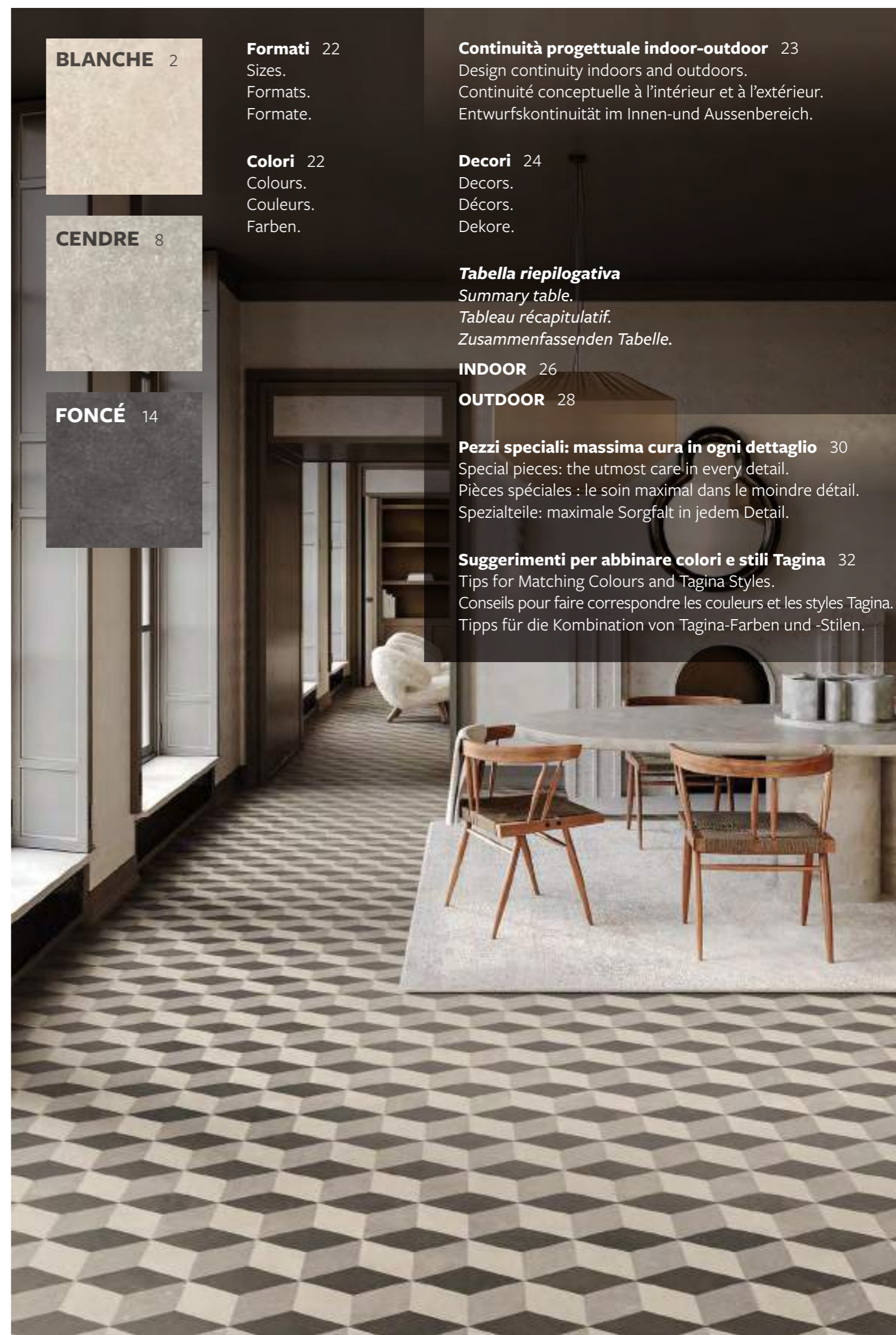

# Un'elegante rilettura materica, al servizio di un luminoso design contemporaneo.

An elegant material reinterpretation for a bright contemporary design.  
Une réinterprétation élégante des matières, au service d'un design contemporain et lumineux.  
Eine elegante Neuinterpretation des Materials im Dienste eines leuchtenden zeitgenössischen Designs.

## BLANCHE



SCALE . STAIRS  
BLANCHE 90x90 Nat. Ret.  
BLANCHE Coprispigolo 1,4x90 Nat. Ret.

PAVIMENTO . FLOOR  
BLANCHE 90x90 Nat. Ret.



# Il sapore della pietra antica rivive con un suggestivo accento di tendenza.

The taste of ancient stone comes back to life with an evocative trendy accent.  
Le goût de la pierre ancienne reprend vie avec un accent suggestif et tendance.  
Der Geschmack von altem Stein wird mit einem suggestiven, trendigen Akzent wiederbelebt.

## CENDRE

TAVOLO . TABLE:  
STATUARIO 6 mm Nat.

PAVIMENTO . FLOOR:  
CENDRE Esagono 25x22 Nat. Nat.  
CENDRE Esagono Astrid 25x22 Nat. Nat.



INDOOR  
CENDRE 60x90 Nat. Ret.

OUTDOOR  
CENDRE 60x90 20 mm Nat. Ret. R11



CENDRE 60x90 20 mm Nat. Ret. R11

SPECIAL PIECES FOR SWIMMING-POOL  
CENDRE Gradone grip bordo piscina + Ang. 30x90 20 mm Nat. Ret. R11  
CENDRE Griglia + Ang. 20x60 20 mm Nat. Ret. R11



# Carattere e prestazioni per gli spazi commerciali di nuova concezione.

Character and performance for newly designed commercial spaces.  
Caractère et performance pour des espaces commerciaux de conception nouvelle.  
Charakter und Leistung für neu gestaltete gewerbliche Räumlichkeiten.

## FONCÉ

INDOOR  
FONCÉ 90x90 Nat. Ret.  
  
OUTDOOR  
FONCÉ 90x90 20 mm Nat. Ret. R11



FONCÉ 90x90 20 mm Nat. Ret. R11



RIVESTIMENTO . WALL  
FONCÉ Mosaico 30x30 Nat. Ret.

LAVABO - WASHBASIN  
Collection CALACATTA GOLD 6 mm Nat.

PAVIMENTO . FLOOR  
FONCÉ Esagono 25x22 Nat. Nat.



# NAMUR

Ogni collezione Tagina rivela la massima cura e una sensibilità artistica raffinata capace di riprodurre la più intima essenza estetica della materia. Colori e trame ricercate si sommano a caratteristiche tecniche di massima qualità grazie alle tecnologie produttive più avanzate. Una superficie Tagina è garanzia di eccellenza e prestigio in ogni genere di spazio legato a emozioni inalterabili nel tempo.

Every Tagina collection shows the utmost attention to detail and a sophisticated artistic sensitivity that reproduces the most intimate aesthetic essence of the material. Refined colours and textures combine with the highest-quality technical characteristics thanks to the most advanced manufacturing technologies. A Tagina surface is a guarantee of excellence and prestige in any kind of environment connected to emotions impervious to time.

Chaque collection Tagina révèle un soin maximal et une sensibilité artistique raffinée capable de reproduire l'essence esthétique la plus intime de la matière. Couleurs et motifs recherchés s'ajoutent à des caractéristiques techniques d'une qualité maximale grâce aux technologies de production les plus avancées. Une surface Tagina est une garantie d'excellence et de prestige dans tous les types d'espace lié à des émotions inaltérables dans le temps.

Jede Tagina-Kollektion zeugt von größter Sorgfalt und einem raffinierten künstlerischen Gespür, das die intimste ästhetische Essenz des Materials wiederzugeben vermag. Raffinierte Farben und Texturen ergänzen sich durch modernste Produktionstechnologien mit hochwertigen technischen Eigenschaften. Eine Oberfläche von Tagina ist eine Garantie für Exzellenz und Wertigkeit in jeder Art von Raum, verbunden mit dauerhaften Emotionen.



CENDRE

FONCÉ



# NAMUR

## FORMATI

Sizes / Formats / Formate

10 mm . 90x90 - 35 1/2"x35 1/2" / 60x90 - 24"x35 1/2" / 60x60 - 24"x24" / Esagono 25x22 - 10"x8 1/2"  
20 mm R11 . 90x90 - 35 1/2"x35 1/2" / 60x90 - 24"x35 1/2" / 60x60 - 24"x24"

## COLORI

Colours / Couleurs / Farben



BLANCHE



CENDRE



FONCÉ

## CONTINUITÀ PROGETTUALE INDOOR-OUTDOOR

Design continuity indoors and out / Continuité conceptuelle à l'intérieur et à l'extérieur / Entwurfskontinuität im Innen-und Aussenbereich



### INDOOR

**Soluzioni contemporanee per l'interior design**  
Contemporary solutions for interior design.  
Solutions contemporaines pour le design intérieur.  
Zeitgemäße Lösungen für das Interior Design.

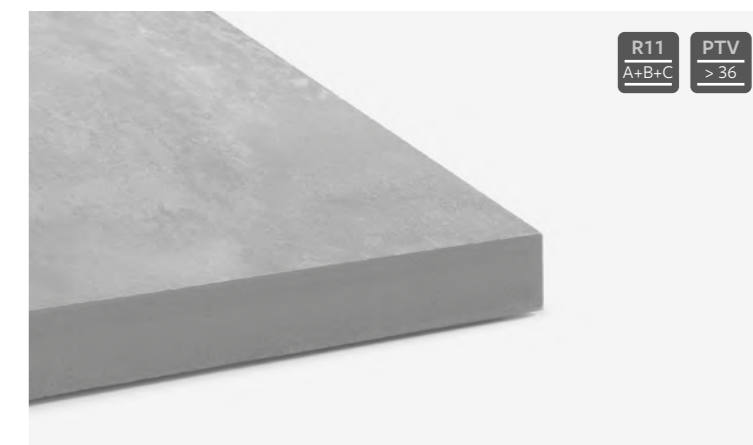

### OUTDOOR

**Versatilità e prestazioni per la progettazione in esterna**  
Versatility and performance for outdoor design.  
Polyvalence et performance pour l'aménagement extérieur.  
Vielseitigkeit und Leistungen für Outdoor-Design.

## SISTEMI DI POSA

Laying systems / Systemes de pose / Verlegearten

**Posa su erba**  
Laying on grass  
Pose sur l'herbe  
Verlegung auf Wiese



**Posa su sabbia**  
Laying on sand  
Pose sur sable  
Verlegung auf Sand



**Posa sopraelevata**  
Raised laying  
Pose surélevée  
Verlegung auf Stelzlagern



**Posa su ghiaia**  
Laying on gravel  
Pose sur gravier  
Verlegung auf Kies



**Posa tradizionale**  
Standard laying  
Pose traditionnelle  
Herkömmliche Verlegung



**Spessore** . Thickness . Epaisseur . Stärke - **10 mm****Gres porcellanato colorato in massa** . Full-body coloured porcelain stoneware . Grès cérame coloré dans la masse . In der Masse gefärbtes Feinsteinzeug.**DECORI**

Decors / Décors / Dekore

**ESAGONO ASTRID****25x22** - 10"x8 1/2"**Fino a 45 grafiche per colore** . Up to 45 graphics per colours . Jusqu'à 45 graphismes par couleur . Bis zum 45 Grafiken pro Farbe

BLANCHE



CENDRE



FONCÉ

**ESAGONO CUBE****25x22** - 10"x8 1/2"**Fino a 42 grafiche** . Up to 42 graphics . Jusqu'à 42 graphismes . Bis zum 42 Grafiken**MOSAICO (5x5)****30x30** - 12"x12"

BLANCHE



CENDRE

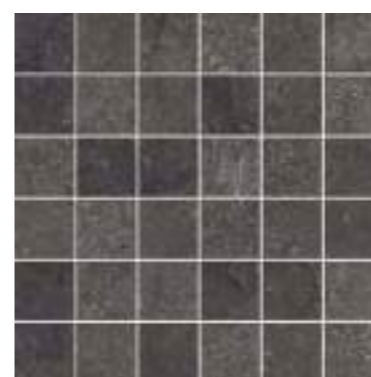

FONCÉ

**COPRISPIGOLO TRIANGOLARE****1,4x90** - 1/2"x35 1/2"

BLANCHE



CENDRE



FONCÉ



All'interno delle scatole il mix dei soggetti del decoro è del tutto casuale. In alcune scatole qualche soggetto potrebbe ripetersi.  
The mix of decor patterns within each box is entirely random. Some of the decor patterns within each box may be the same.  
A l'intérieur des boîtes le mélange des sujets de décoration est complètement aléatoire. Dans certaines boîtes parfois les sujets peuvent se répéter.  
Im Inneren der Kartons kommt die Mischung der Motive einzelner Dekore völlig zufällig vor. In einigen Kartons können sich einige Motive wiederholen.

I decori si abbinano al fondo ma possono essere di tonalità diversa.  
Decors match the base but may be of a different tone.  
Les décors sont assortis au fond, mais les tonalités peuvent être différentes.  
Die Dekore passen zum Unifliese, können jedoch unterschiedliche Farbtöne aufweisen.

**Spessore . Thickness . Epaisseur . Stärke - 10 mm**

**Gres porcellanato colorato in massa.** Full-body coloured porcelain stoneware. Grès cérame coloré dans la masse. In der Masse gefärbtes Feinsteinzeug.

**INDOOR**

TABELLA RIEPILOGATIVA  
Summary table  
Tableau récapitulatif  
Zusammenfassende Tabelle

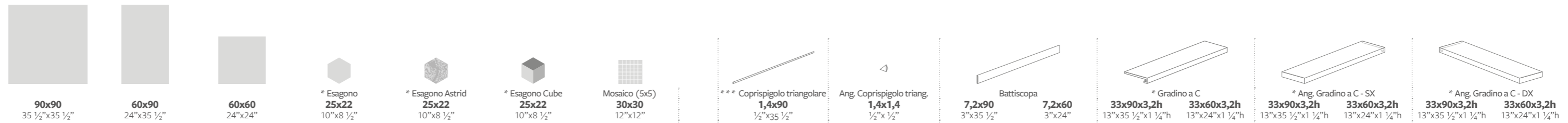

SPESSORE - THICKNESS - EPAISSEUR - STÄRKE		10 mm	10 mm	10 mm	10 mm	10 mm	10 mm	10 mm	10 mm	10 mm	10 mm	10 mm	10 mm	10 mm	10 mm	10 mm	10 mm			
	□ Nat. Ret.	136001	136007	136011				136301		136401	136411	136101	136111	136201	136211	136231	136251	136221	136241	
	■ Nat. Nat.				136021	136027	136030													
	□ Nat. Ret.	136003	136008	136013				136303		136403	136413	136103	136113	136203	136213	136233	136253	136223	136243	
	■ Nat. Nat.				136023	136028	136030													
	□ Nat. Ret.	136005	136009	136015				136305		136405	136415	136105	136115	136205	136215	136235	136255	136225	136245	
	■ Nat. Nat.				136025	136029	136030													
IMBALLI - PACKAGING EMBALLAGE - VERPACKUNG																				
	Pallet	Pallet	Pallet	Pallet	Pallet	Pallet	Pallet	Pallet				Pallet	Pallet	Pallet	Pallet	Pallet	Pallet	Pallet	Pallet	Pallet
		94x120	94x120	80x120	80x120	80x120	80x120	80x120				80x120	80x120	80x120	80x120	80x120	80x120	80x120	80x120	80x120
N°																				
m²																				
Kg																				
x		2	2	3	9	9	9	11		6		8	14	2	4	1	2	1	2	
m² x		1,62	1,08	1,08	0,37	0,37	0,37	0,99												
Kg x		37	24	24	8,2	8,2	8,2	20,5		2		11	11,7	16,5	22	8,5	11,5	8,5	11,5	
x		20	48	40	72	72	72													
m² x		32,4	51,84	43,2	26,64	26,64	26,64													
** Kg x		760	1172	980	611	611	611													
h x		64	75	75																
Imballo (tara) - Packaging (tare)		(20)	(20)	(20)	(20)	(20)	(20)	(20)				(20)	(20)	(20)	(20)	(20)	(20)	(20)	(20)	(20)

I pesi riportati in tabella sono indicativi e potrebbero essere soggetti a leggere variazioni.  
The weights stated in the chart may undergo slight changes for production reasons.  
Les poids indiqués dans le tableau peuvent subir de légères variations pour des raisons de production.  
Die in der Tabelle angegebenen Gewichte können aus Produktionsgründen geringfügigen Abweichungen unterliegen.

Non si garantisce l'abbinabilità tra fondi di spessori diversi e tra fondo e pezzo speciale.  
It is not guaranteed that background tiles with different thicknesses can be used together, nor is it guaranteed for background tiles and trims.  
Nous ne garantissons pas la possibilité de combiner des carrelages de sol de différentes épaisseurs et un carrelage de sol avec une pièce spéciale.  
Die Kombinierbarkeit von Fliesen unterschiedlicher Stärke sowie zwischen Fliese und Formteil kann nicht garantiert werden.

\* A disposizione solo su richiesta. Tempi di consegna 30 gg.  
Available upon request only. Delivery terms: 30 days.  
Disponible seulement sur requête. Délais de livraison: 30 jours.  
Verfügbar auf Anfrage. Lieferzeit: 30 Tage.

\*\* Il peso è comprensivo dell'imballo.  
The total weight includes the packaging.  
Le poids comprend aussi l'emballage.  
Das Gesamtgewicht enthält auch die Verpackung.

\*\*\* Vendita a scatola completa.  
Full box sale.  
Vente à la boîte complète.  
Volle Kartons.

□ Naturale e rettificato.  
Natural rectified.  
Naturel et rectifié.  
Natur Oberfläche und rektifiziert.

■ Naturale e naturale.  
Natural and natural.  
Naturel et naturel.  
Natur natur.

**Spessore . Thickness . Epaisseur . Stärke - 20 mm R11**

**Gres porcellanato colorato in massa.** Full-body coloured porcelain stoneware. Grès cérame coloré dans la masse. In der Masse gefärbtes Feinsteinzeug.

**OUTDOOR**

TABELLA RIEPILOGATIVA  
Summary table  
Tableau récapitulatif  
Zusammenfassenden Tabelle

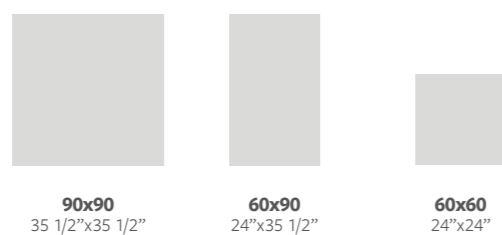

SPESORE - THICKNESS - EPAISSEUR - STÄRKE	20 mm	20 mm	20 mm
<b>BLANCHE R11</b> □ Nat. Ret.	136041	136045	136051
<b>CENDRE R11</b> □ Nat. Ret.	136042	136046	136052
<b>FONCÉ R11</b> □ Nat. Ret.	136043	136047	136053
<b>IMBALLI - PACKAGING</b> EMBALLAGE - VERPACKUNG			
	<b>Pallet</b> 94x94	<b>Pallet</b> 94x120	<b>Pallet</b> 80x120
<b>N°</b>			
<b>m²</b>			
<b>Kg</b>			
<b>x</b>	1	1	2
<b>m² x</b>	0,81	0,54	0,72
<b>Kg x</b>	37	24	32
<b>x</b>	30	45	32
<b>m² x</b>	24,3	24,3	23,04
<b>** Kg x</b>	1130	1100	1044
<b>h x</b>	80	75	75
<b>Imballo (tara) - Packaging (tare)</b>	(20)	(20)	(20)

**PEZZI SPECIALI PER ESTERNO 20 mm R11** - □ Nat. Ret.

Special pieces for outdoor - Pièces spéciales pour extérieur - Formteile für Aussenbereich

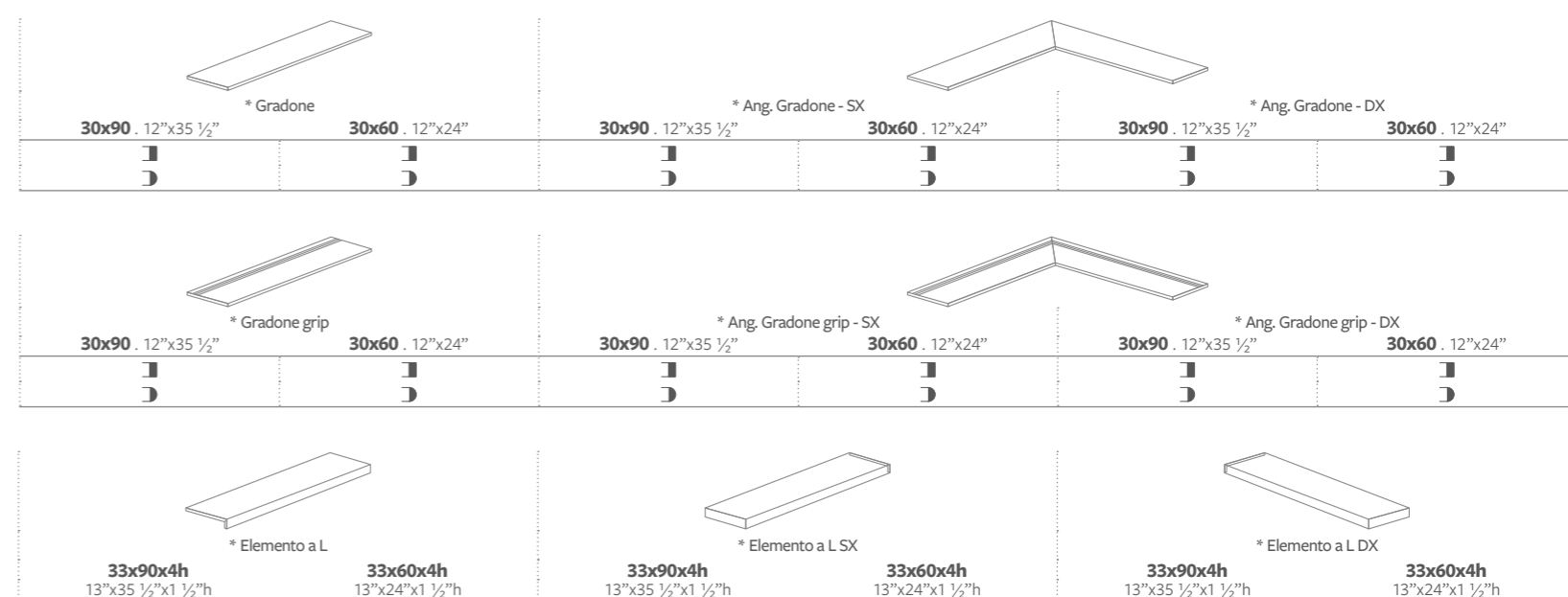

**PEZZI SPECIALI PER PISCINA 20 mm R11** - □ Nat. Ret.

Special pieces for swimming pool - Pièces spéciales pour piscine - Formteile für Schwimmbad

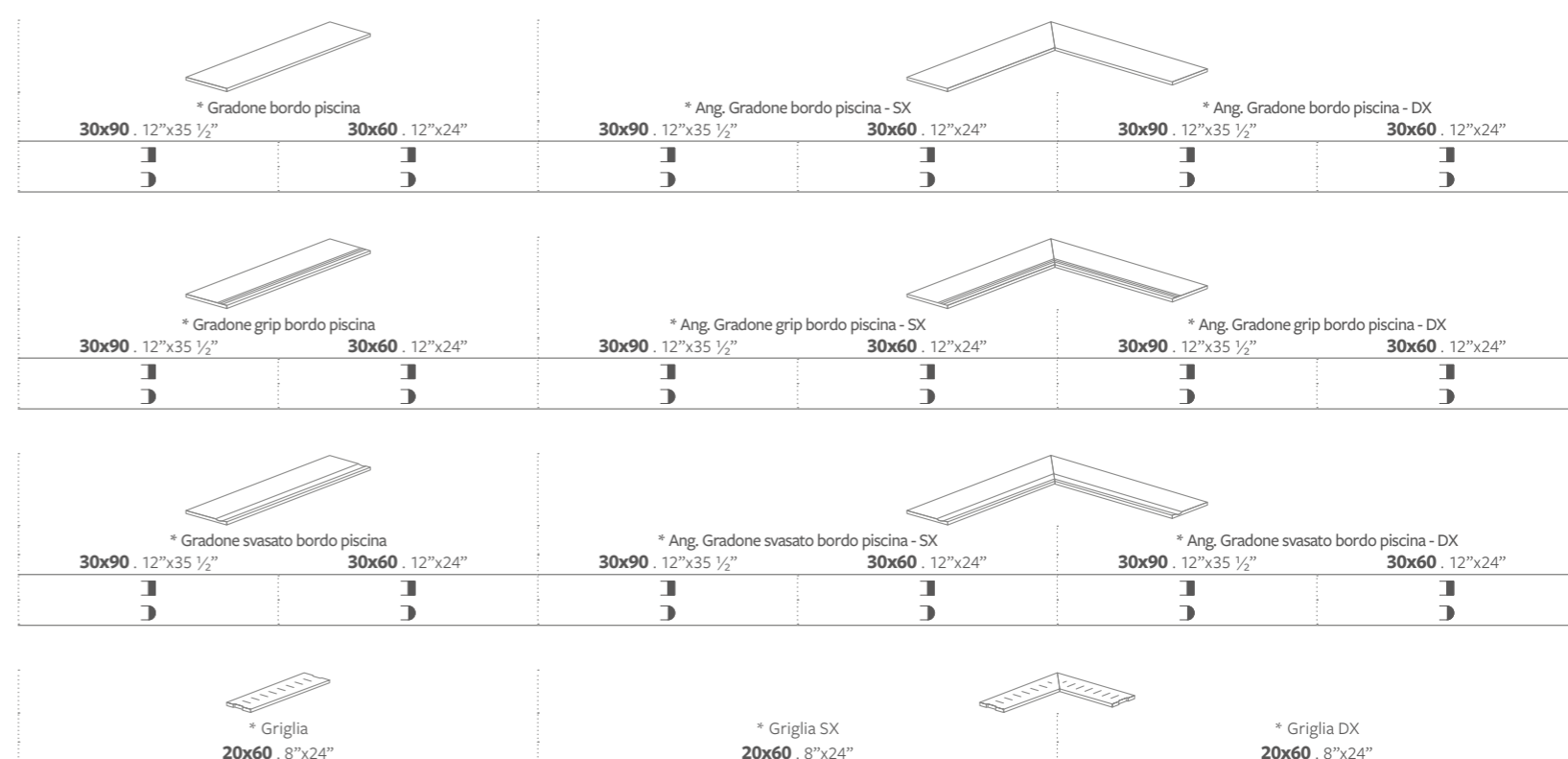

I pesi riportati in tabella sono indicativi e potrebbero essere soggetti a leggere variazioni.  
The weights stated in the chart may undergo slight changes for production reasons.  
Les poids indiqués dans le tableau peuvent subir de légères variations pour des raisons de production.  
Die in der Tabelle angegebenen Gewichte können aus Produktionsgründen geringfügigen Abweichungen unterliegen.

Non si garantisce l'abbinabilità tra fondi di spessori diversi e tra fondo e pezzo speciale.  
It is not guaranteed that background tiles with different thicknesses can be used together, nor is it guaranteed for background tiles and trims.  
Nous ne garantissons pas la possibilité de combiner des carrelages de sol de différentes épaisseurs et un carrelage de sol avec une pièce spéciale.  
Die Kombinierbarkeit von Fliesen unterschiedlicher Stärke sowie zwischen Fliese und Formteil kann nicht garantiert werden.

\*\* Il peso è comprensivo dell'imballo. □ Naturale e rettificato.  
The total weight includes the packaging. Natural rectified.  
Le poids comprend aussi l'emballage. Naturel et rectifié.  
Das Gesamtgewicht enthält auch die Verpackung. Natur Oberfläche und rektifiziert.

Per maggiori informazioni su imballi e codici articolo dei PEZZI SPECIALI 20 mm R11 e sui SUPPORTI PER PAVIMENTAZIONI SOPRAELEVATE, potete consultare il nostro BOOK (anche da sito internet, nell'area "download").  
For more information on packaging and item codes of SPECIAL PIECES 20 mm R11 and on SUPPORTS FOR RAISED PAVING SYSTEM, please refer to our BOOK (also available for download on our website, in the "download" area).  
Pour plus d'informations sur les emballages et les codes des PIÈCES SPÉCIALES 20 mm R11 et sur les SUPPORTS POUR LES SYSTÈMES DE CARRELAGES SURÉLEVÉS, consultez notre BOOK (sur notre site, section "téléchargement").  
Weitere Informationen zu Verpackungen und Artikelcodes FORMTEILE IN 20 mm R11 und STELZLAGERN FÜR DOPPELBODEN finden Sie in unserem BOOK (auch auf der Website, im Bereich "Download").

\* A disposizione solo su richiesta. Tempi di consegna 30 gg.  
Available upon request only. Delivery terms: 30 days.  
Disponibile seulement sur requête. Délais de livraison: 30 jours.  
Verfügbar auf Anfrage. Lieferzeit: 30 Tage.

▬ Costa retta. Straight edge. Bord droit. Gerade Kante.  
▬ Costa toro. Bullnose edge. Bord boudin. Abgerundete Kante.



# Pezzi speciali: massima cura in ogni dettaglio

Special pieces: the utmost care in every detail.

Pièces spéciales : le soin maximal dans le moindre détail.

Spezialteile: maximale Sorgfalt in jedem Detail.



## Il fascino tradizionale del gradino a "C"

The traditional appeal of the "C" step.

Le charme traditionnel de l'étape « C »

Der traditionelle Charme der „C“-Stufe.

Tagina pone attenzione a tutte le componenti architettoniche degli spazi da abitare. Ai gradini sono dedicati pezzi speciali appositamente progettati per ottenere il massimo risultato estetico. La gamma comprende un elemento "gradino a C" al quale si possono affiancare gli elementi che completano gli angoli sinistro e destro.

Tagina takes great care over all the architectural elements of the living spaces. Special pieces are used for the stairs, specially designed to obtain the maximum aesthetic result. The range includes a "C-step" element which can be combined with the elements that complete the left and right corners.

Tagina prête attention à toutes les composantes architecturales des espaces de vie. Les étapes sont dédiées à des pièces spéciales spécialement conçues pour obtenir un résultat esthétique maximal. La gamme comprend un élément « marche en C » auquel vous pouvez assortir les autres éléments qui complètent les angles gauche et droit.

Tagina achtet auf alle architektonischen Komponenten der Wohnräume. Den Stufen sind Spezialteile gewidmet, um ein optimales ästhetisches Ergebnis zu erzielen. Das Sortiment umfasst ein „C-Stufen-Element“, das durch Elemente zur Vervollständigung der linken und rechten Ecke ergänzt werden kann.

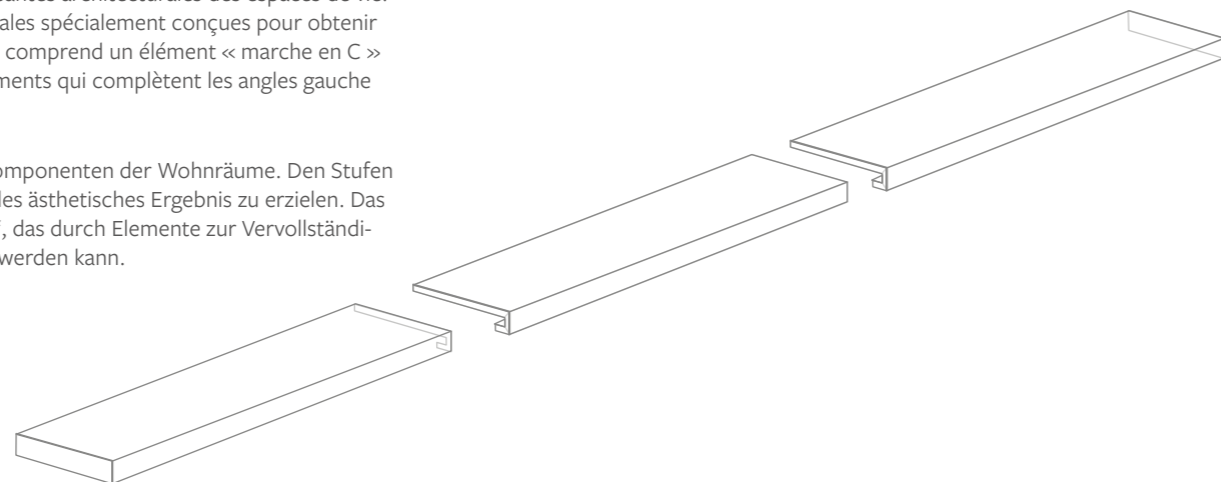

## Il "coprispigolo triangolare"

The "triangular edge cover".

Le « cache-arête triangulaire »

„Dreieckiger Kantenschutz“

La gamma della collezione include l'elemento "Coprispigolo triangolare" e "Angolo Coprispigolo triangolare". Consentono di risolvere con eleganza e semplicità problematiche legate alla congiunzione delle lastre in presenza di spigoli e angoli. È possibile adottare questa soluzione sia a rivestimento che a pavimento ad esempio per realizzare gradini o per comporre volumi geometrici.

The range of the collection includes the "Triangular edge cover and triangular corner edge cover" element. They allow problems encountered to be solved elegantly and simply when joining slabs where there are edges and corners. It is possible to adopt this solution both for cladding and flooring, e.g. to create steps or compose geometric volumes.

La gamme de la collection comprend l'élément « Cache-arête triangulaire et Angle Cache-arête Triangulaire ». Ils permettent de résoudre avec élégance et simplicité les problèmes liés à l'assemblage des dalles en présence de bords et de coins. Il est possible d'adopter cette solution aussi bien pour le revêtement que pour le dallage, par exemple pour créer des marches ou composer des volumes géométriques.

Das Sortiment der Kollektion umfasst das Element „Dreieckiger Kantenschutz und Dreieckige Eckabdeckung“. Beide Elemente ermöglichen, mit Eleganz und Einfachheit alle Probleme zu lösen, die mit dem Zusammenfügen der Platten bei Vorhandensein von Kanten und Ecken zusammenhängen. Diese Lösung kann sowohl für Verkleidungen als auch für Böden verwendet werden, beispielsweise um Stufen oder geometrische Volumen zu schaffen.



# Suggerimenti per abbinare colori e stili Tagina

Tips for Matching Colours and Tagina Styles.

Conseils pour faire correspondre les couleurs et les styles Tagina.













Tipps für die Kombination von Tagina-Farben und -Stilen.



RIVESTIMENTO . WALL  
FONCE Mosaico 30x30 Nat. Ret.

LAVABO - WASHBASIN  
Collection CALACATTA GOLD 6 mm Nat.

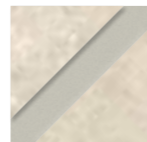
PAVIMENTO . FLOOR  
FONCE Esagono 25x22 Nat. Nat.

	BLANCHE	CENDRE	FONCÉ		
<b>CONCRETE &amp; DESIGN</b>  <b>NAMUR PIETRA DI LUNA</b>	 ARGENT	 BEIGE	 ARGENT		
<b>MARBLE &amp; ONYX</b>  <b>NAMUR METAL</b>	 PEARL	 TITANIUM	 CORTEN	 IRON	 CORTEN
<b>MARBLE &amp; ONYX</b>  <b>NAMUR CALACATTA GOLD</b>	 CALACATTA GOLD		 CALACATTA GOLD		
<b>MARBLE &amp; ONYX</b>  <b>NAMUR STATUARIO</b>	 STATUARIO	 STATUARIO	 STATUARIO		
<b>MARBLE &amp; ONYX</b>  <b>NAMUR SEGESTA</b>	 SEGESTA BLU		 SEGESTA CAMEL		
<b>WOOD</b>  <b>NAMUR EVOQUE</b>		 ROVERE	 KORINA		
Colore consigliato per la Fuga Recommended joint colour. Couleur d'échappement recommandée. Empfohlene Farbe für die Fuge.	 RAL 9002 NCS 1502-Y	 RAL 7044 NCS 2005-Y20R	 RAL 7037 NCS 5000-N		

Per le condizioni generali di vendita e le caratteristiche tecniche consultare [www.tagina.it](http://www.tagina.it)  
 General terms and Sales conditions and Technical features are available on our website [www.tagina.it](http://www.tagina.it)  
 Les Conditions général de vente et les Caractéristiques techniques sont disponibles sur le site web [www.tagina.it](http://www.tagina.it)  
 Allgemeine Verkaufsbedingungen und technische Eigenschaften sind auf unsere Website verfügbar: [www.tagina.it](http://www.tagina.it)

Tagina S.p.A. si riserva di modificare, senza alcun preavviso, il packaging dei prodotti, le grafiche, i colori e i decori riportati nelle immagini che sono pertanto da ritenersi indicative.

Tagina S.p.A. reserves the right to change the product packaging, the patterns, colours and decorations shown in the pictures without any prior notice. These aspects, therefore should be considered for illustrative purposes only.

Tagina S.p.A. se réserve le droit de modifier, sans préavis, l'emballage des produits, les graphismes, les couleurs et les décors représentés dans les images, fournies à titre indicatif.

Die Tagina S.p.A. behält sich vor, die Verpackung der Produkte, die in den Abbildungen gezeigten Grafiken, Farben und Dekors sowie ohne vorherige Ankündigung zu ändern.

**PULIZIA E MANUTENZIONE DEL PRODOTTO**

Product cleaning and maintenance  
Nettoyage et entretien du produit  
Reinigung und Wartung des Produkts



100% Made in Italy



**Tagina** S.p.A.  
Via Emilia Ponente, 925  
48014 Castel Bolognese (RA) - Italy  
Tel. +39 0545 197 7303

tagina.it -  DAFIN GROUP

Follow us

